



Part of



2N[®] IP Style

Setting a new standard for video intercoms



Agenda

1. Why we have developed 2N® IP Style
2. Innovations and the new platform
3. Mounting and accessories
4. Options for configuration
5. Product comparisons

A dark, textured smartphone case, possibly made of carbon fiber or a similar material, is shown vertically. It features a camera lens at the top and a small logo at the bottom. The case is set against a dark blue background with a subtle light gradient.

Why did we develop it?

Product positioning

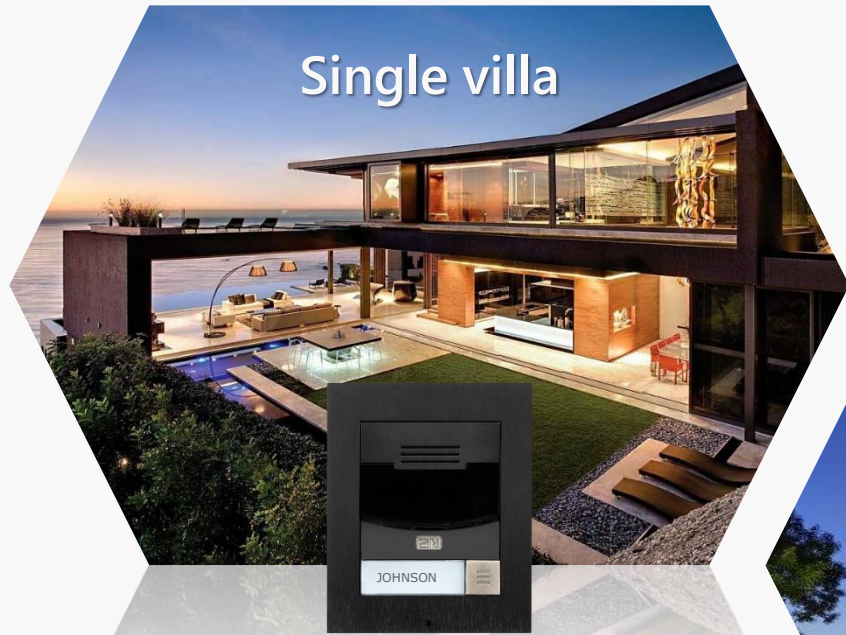



“For high-end office and residential buildings customers request an even better and more luxurious intercom. One with large touch display!”

What exactly do customers want?

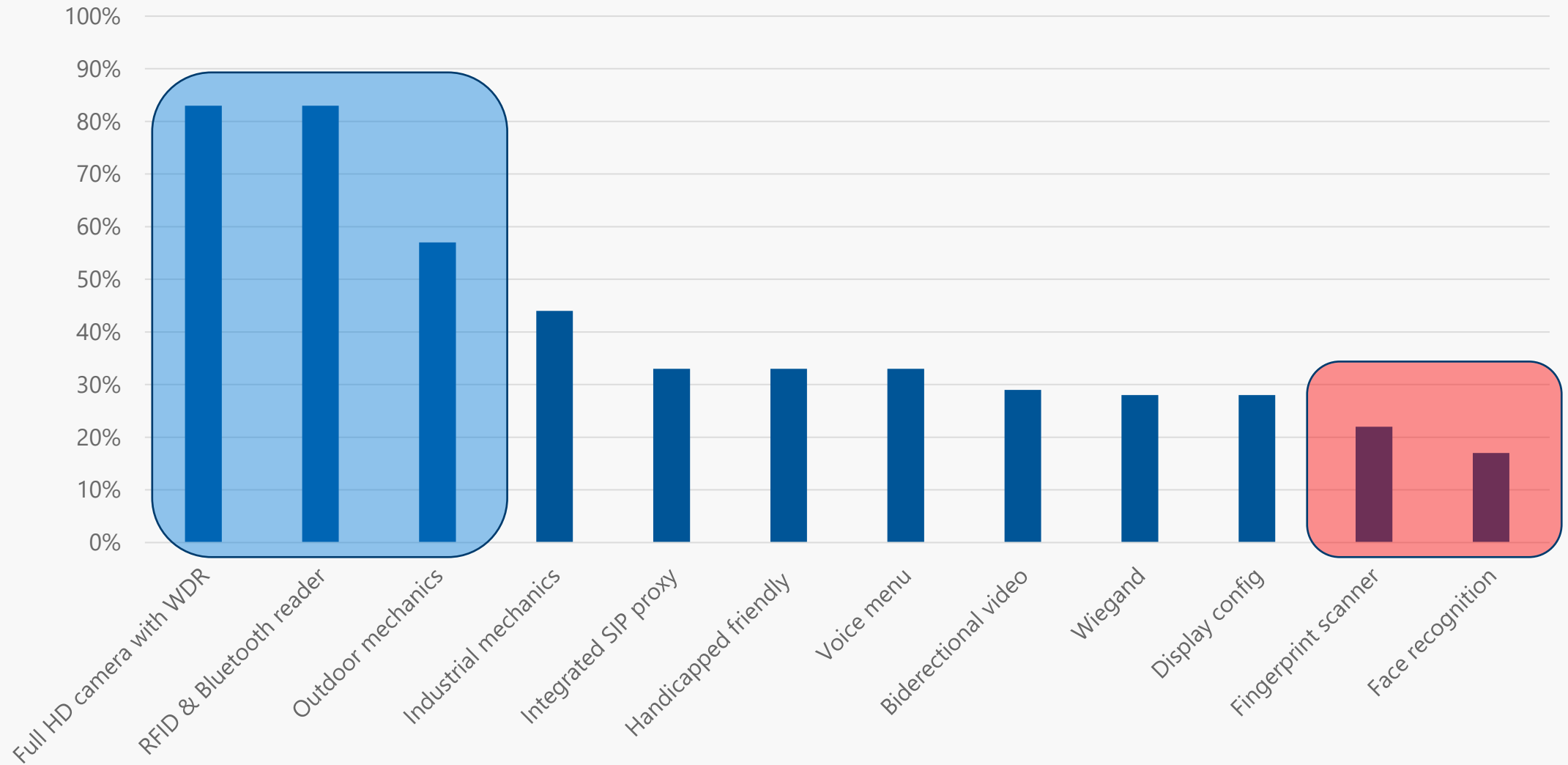



2N[®] IP Style

New flagship intercom with full HD camera, next generation mobile access technology, and large display in a sleek design.

The image features a dark background with glowing blue and purple elements. In the upper left, there is a circular sensor or lens with concentric rings, emitting a purple glow. Below it, a blue, angular shape resembling a stylized 'L' or a corner of a frame is visible. In the lower right, there is a small icon of three curved lines, suggesting a signal or wireless connection. The overall aesthetic is high-tech and futuristic.

What makes it unique?



AXIS ARTPEC-7 chip at the heart of the image

Thanks to the Axis platform, 2N[®] IP Style defines new standards for video intercoms.



5 MP

Camera of the future

High resolution video processing

QHD (1440p) used in the RTSP stream

FullHD (1080p) used in SIP call

Multiple simultaneous full HD streams

Wide dynamic range (Forensic WDR)

Perfect picture even in changing light conditions



2N[®] IP Style (with WDR)

2N[®] IP Verso (w/o WDR)

(Typical of IP intercoms in the field)



We make dark areas bright again

High sensitivity image sensor and ARTPEC-7 chip allows to keep color image where typical intercoms would have to switch to IR mode, or not see anything at all



Premium 10" display

Big screen with 1280x800 resolution for sharp text and graphics

The extreme brightness guarantees **excellent readability** even in sunlight

Immediate response to any touch – the same user experience as you expect from top smartphones

Smooth animations as expected of a premium product



Customizable UI

Two different ways of displaying the intercom's user interface

MDU buildings – list of all residents in alphabetic order (in flat structure)

Office – list of companies' logos (users are in the directory structure)

Idle mode supports: slideshow, pictures, static logo or address of the building

3 in 1 access control



WaveKey mobile access

Fastest mobile access control technology with proven reliability

Frictionless distribution of credentials

Modes: Touch, Tap in app, Motion, Card



Multifrequency RFID

All possible card technologies in one package – you don't have to think about what card you have

Supports **secured HID cards** (SE, Prox)



Smart Pin Keypad

Multi factor authentication, backup or simple method of authentication

Security feature: **scrambled keypad**



Pleasure to install

Our patented mounting mechanisms minimized the possibility of incorrect installation:

Tilt-out system – to slide the intercom into the installation box

Elevation system – change the depth of the recessed box if the box was too deep



Certified durability

IK08 certified glass will easily deal with daily intensive use with no signs of scratches or worn

4mm chemically hardened glass withstands hits and vandal attacks

IP65 ingress protection ensures resistance against heavy rain and dusty environment

Display resistant against water, heat, and direct sunlight will serve your guests in any country



Mounting and accessories

Main unit

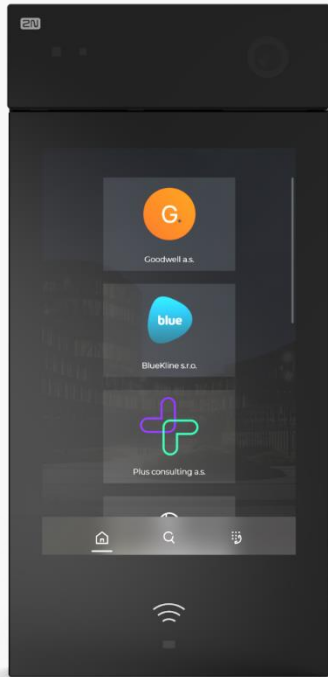

Always choose a box
(mandatory)

Surface mount box

Mounting box to install the 2N® IP Style intercom on the surface of a wall

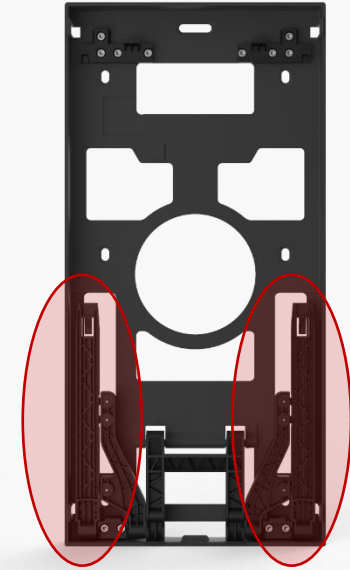

Flush mount box

Accessory for recessed installation with a special elevating function. It helps you align the intercom with a wall's surface.

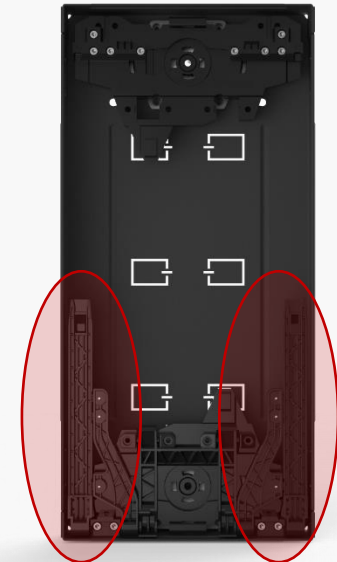

Both boxes has a unique **tilt-out mechanism** which gives you plenty of room to work with cabling.

Special accessories

2N[®] IP Style is equipped with Vbus connector

The same one used by 2N[®] IP Verso or 2N Access Unit 2.0 for the connection of additional modules

Why to use Vbus connector on 2N[®] IP Style?

Connection of Wiegand module to integrate the intercom with 3rd party access control systems

Connection of any reader from 2N[®] IP Verso on the indoor side of the entrance (OUT reader)



Additional accessories (common)



2N® Security Relay

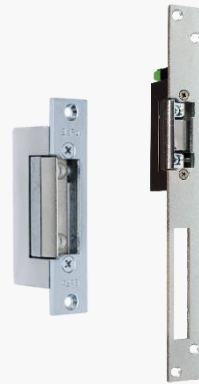

Door strikes



RFID cards and fobs



External USB readers



PoE+ injector



External IP relay

Recommended installation

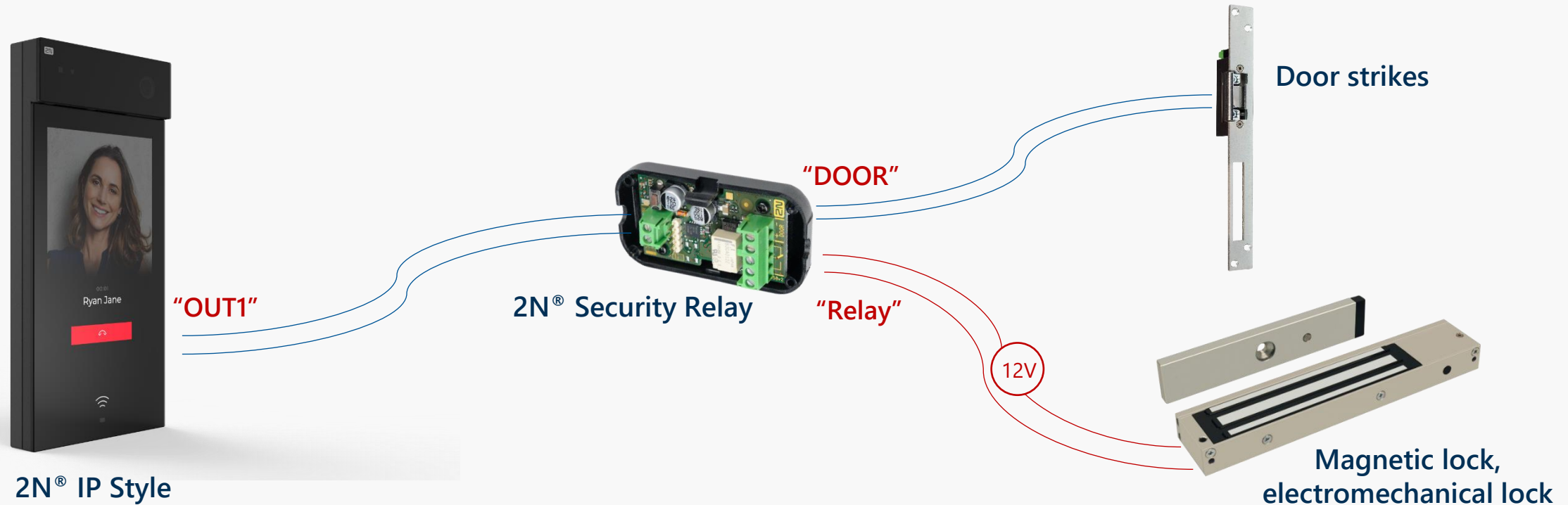

For security reasons we strictly recommend you to:

- always use an active OUT1 for any door strike / lock connection
- always connect 2N® Security Relay between the 2N® IP Style and door lock

Part numbers

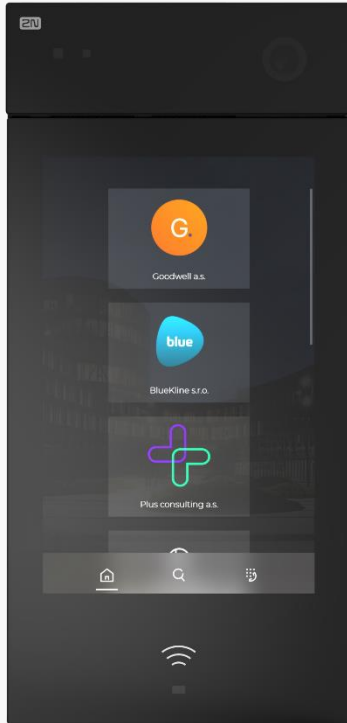

2N® IP Style
9157101

9157101-S (Supports secured cards; HID SE and HID Prox)

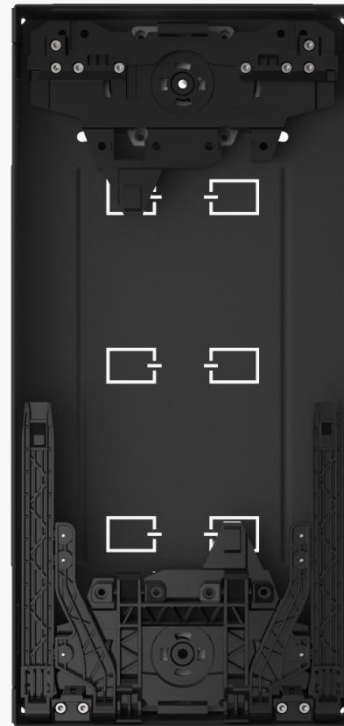

Flush mount box
9157001

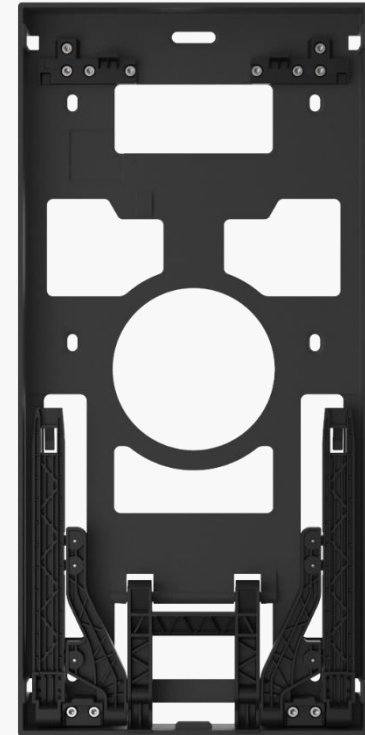

Surface mount box
9157002

Options for configuration

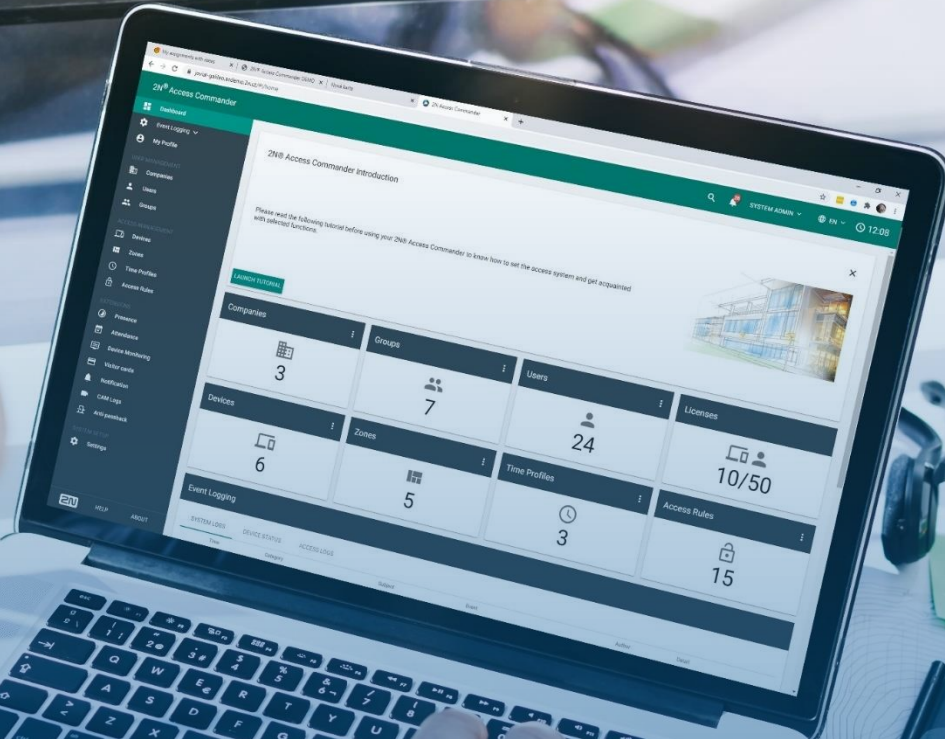

Choose the right configuration tool

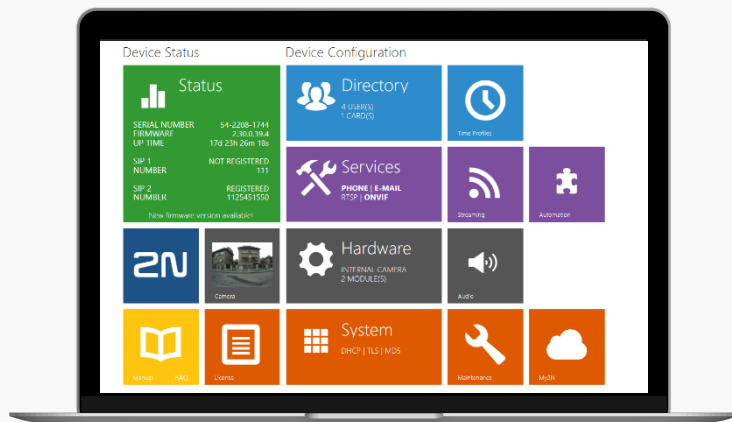

Web interface of the intercom

Suitable for **very small installations** with up to 2 or 3 devices – no bulk management

Web configuration interface allows you to config every single parameter of the intercom

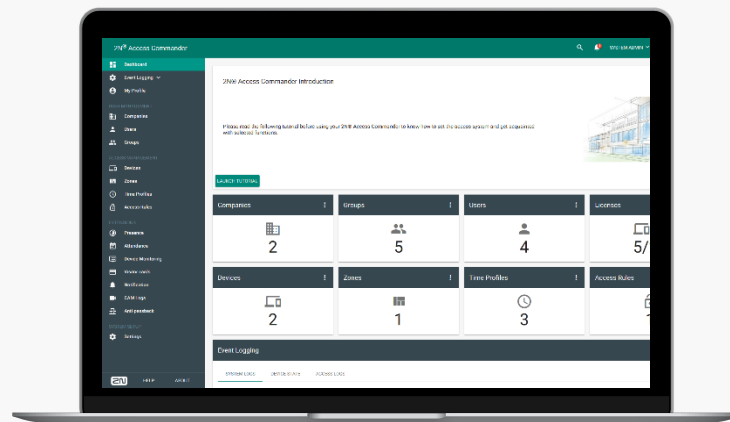

2N® Access Commander

Tailored to **SMB/SME type of installation** with dozens of readers and intercoms

Professional access control SW for bulk management, monitoring and advanced feature settings

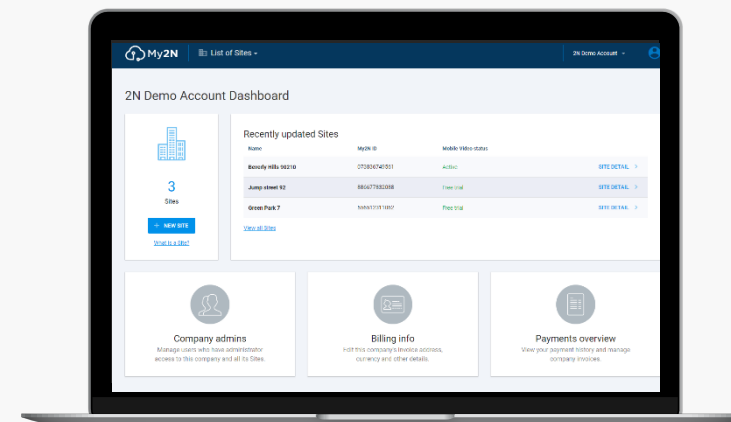

2N® Remote Configuration

Designed for a **residential (MDU) projects** with couple of intercoms, readers and many indoor answering units

Simple remote configuration without any network settings – saving on travel cost

Product positioning & comparisons





Display resolution: 1280x800

Camera: full HD (5MP), max. QHD (2560x1920)

Modularity: no (all in one device; two part numbers)

Vertical: high end (luxury) MDU and office

Price: about 30% higher than 2N® IP Verso



Display resolution: 320x214

Camera: HD, video 640x480, JPEG 1280x960

Modularity: fully modular (according to the customer's need)

Vertical: mid / high end MDU and office buildings

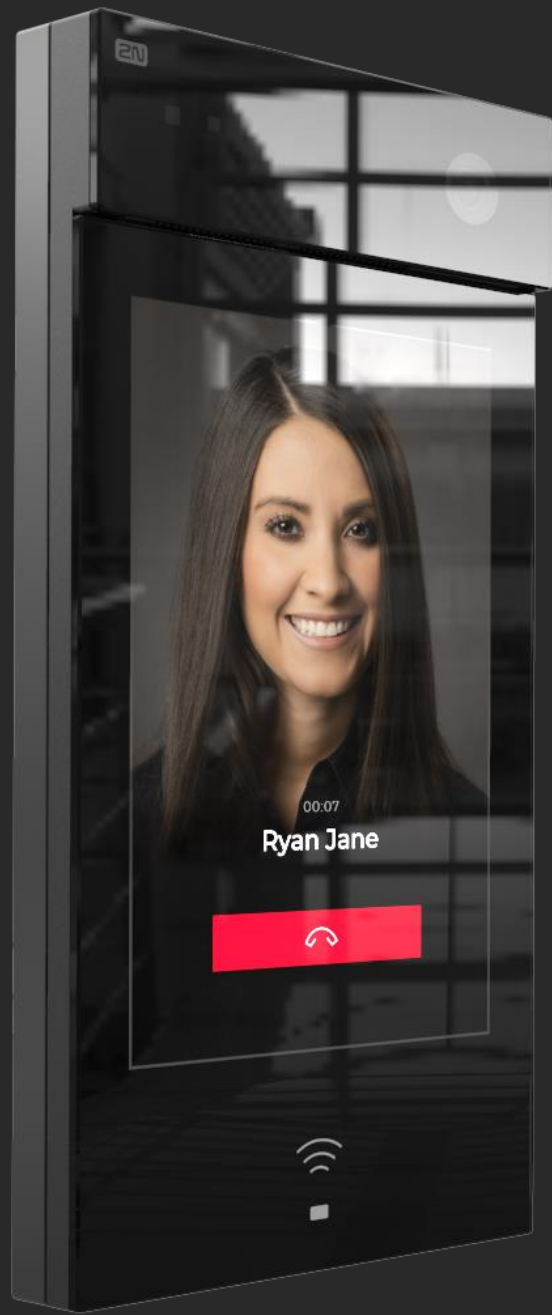

IP intercom with excellent camera and exceptional display

Easy to quote thanks to only two part numbers!

Premium product that opens a door to new high-end projects



Part of



2N[®] IP Style

The best of IP intercoms and IP cameras in one device