

ABT-S106/S136/S206 ABT-S2010/S2710

Ceiling-mounted Prompt Installation Loudspeakers

- ✓ Full compliance with EN 54-24 Standards
- ✓ Certificate of Conformity issued by ITB:
for ABT-S106/S136: 1488-CPD-0171/W
for ABT-S2010/S2710: 1488-CPD-0170/W

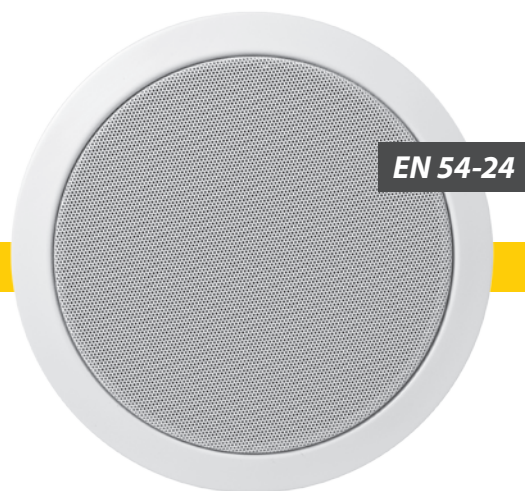

Ceiling-mounted fire alarm loudspeakers ABT-S106 and ABT-S136 are designed for applications which require the minimum size at the maximum sound quality. Their parameters have been carefully selected to match the operating requirements in the rooms exposed to after-sound and high-humidity.

Ceiling mounted fire alarm ABT-S2010 and ABT-S2710 loudspeakers are designed for operations at high acoustic levels and the highest reduction in power supply. Actual wide band high efficiency ensures the best understanding of verbal messages. Their parameters have been carefully selected to comply with false ceiling applications, both at standard and considerably elevated ceiling-to-floor distance.

Thanks to the most advanced technologies the ABT-S series loudspeakers combine excellent acoustic parameters and high aesthetics with resistance to mechanical damages and varying weather conditions. They are distinguished by easy and quick installation.

Quality standards and audio characteristics have been confirmed through multiple tests and trials employing such facilities as e.g. echoproof chamber, resistance and integrity testing equipment, as well as chambers for resistance to weather and air humidity testing.

The need to maintain the best acoustic parameters, even with easily installed fire-protecting screens, was the idea underlying

the design process. The ABT-S series loudspeakers ensure a balanced sound which is extremely important in emission of highly understandable speech and reliable music reproduction.

The series of ceiling-mounted ABT-S loudspeakers is noticeable thanks to its elegant looks. The loudspeaker part which becomes visible after the installation is protected by means of electroplating and covered by a common and aesthetic white paint coat (RAL 9003) – optionally available other colours (RAL palette).

The entire ABT-S series is equipped with a standardized fire dome made of soft steel and supplied with two cable penetrations with rubber glands. Special jig for sling assembling facilitates quick installation. The delivery comprises the 1-metre long sling. Two ceramic blocks and fireproof wiring coupled with temperature limit fuse are located under the screen. This solution ensures 100% protection of the sound-transmitting line from any break or short-circuits which may be produced as a result of loudspeaker burn.

The ABT-S loudspeakers have been successfully tested by means of the most rigorous trials at the temperature of 822°C. The individual power rating is selected by means of connection with applicable transformer branch.

ABT-S series loudspeakers equipped with fire dome and thermal protections entirely comply with EN 54-24 Standards. In order to

ensure 100% consistency with the highest quality standards we test our loudspeakers following the most meticulous procedures that warrant high parameters of sound emission, safety, and reliability.

In spite of the fact our loudspeakers are designed for the highest reliability under fire conditions, their acoustic parameters and attractive low prices make them successful in any and all public address systems.

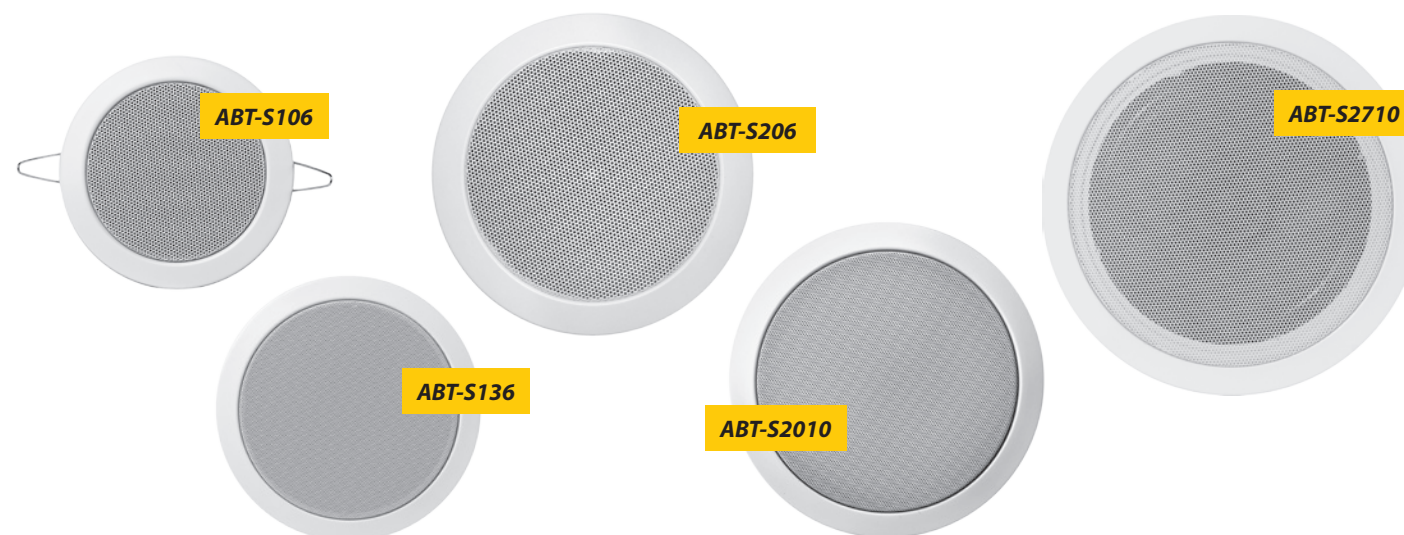

ABT-S106/S136

- » **Minimum dimensions**
- » **A and C working environment, ideal for bathrooms**
- » **Exceptionally reliable reproduction of full band music**
- » **The highest level of verbal communication understanding**
- » **Elegant looks**
- » **6 W transformer allowing a precise selection of loudspeaker output power**
- » **100% protection of line from breaks and short-circuits at the temperature of 822°C**

ABT-S206/S2010/S2710

- » **High efficiency**
- » **High acoustic pressure level**
- » **Exceptionally reliable full band music reproduction**
- » **The highest level of speech understanding**
- » **Elegant looks**
- » **10 W transformer allowing precise selection of loudspeaker output power**
- » **100% protection of line from breaks and short-circuits at the temperature of 822°C**

	ABT-S106	ABT-S136	ABT-S206	ABT-S2010	ABT-S2710
Electrical					
Rated power, W	6	6	6	10	10
Tappings 100 V line, W	6/3/1,5/0,75	6/3/1,5/0,75	6/3/1,5/0,75	10/5/2,5/1,25	10/5/2,5/1,25
Transformer impedance, Ω 100V	1667/3333/6667/13333	1667/3333/6667/13333	1667/3333/6667/13333	1000/2000/4000/8000	1000/2000/4000/8000
Driver impedance, Ω	8	8	8	8	8
Effective frequency range, Hz	100–20000	60–20000	82–20000	150–20000	100–20000
Sensitivity @ 4 m, 1 W, dB	65	68	79	77	78
SPL @ 4 m, Rated power, dB	76	78	87	92	93
SPL @ 1 m, 1 W, dB, Test signal bandwidth 300 Hz–6 kHz	80	82	91	94	95
SPL @ 1 m, Rated power, dB, Test signal bandwidth 300 Hz–6 kHz	88	90	99	104	105
Dispersion at 500 Hz / 1 kHz / 2 kHz / 4 kHz, [°]	180 / 153 / 131 / 80	180 / 131 / 124 / 76	180 / 180 / 160 / 85	180 / 109 / 153 / 80	180 / 98 / 80 / 69
Environmental					
Environmental type / IP Rating according to EN 54-24	A, C / IP21C	A, C / IP21C	A	A / IP21C	A / IP21C
IP Rating	32	32	32	32	32
Min / Max Amb Temp	-10°C / 55°C	-10°C / 55°C	-10°C / 55°C	-10°C / 55°C	-10°C / 55°C
Mechanical					
Dimensions, mm	Height 108, ø 104	Height 116, ø 135	Height 130, ø 204	Height 110, ø 200	Height 120, ø 267
Net Weight, kg	0,8	0,9	1,5	1,5	1,8
Colour	White (RAL 9003)				
Material	Steel				
Mounting	Spring clamp				
Cut-out, mm	ø 85	ø 115	ø 170	ø 170	ø 227
Option					
For DC line monitoring	Capacitor				
Colour optional	RAL Palette				
Ease Model					
		✓		✓	

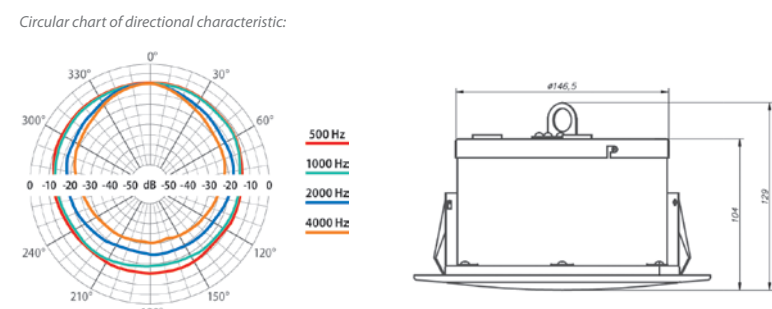
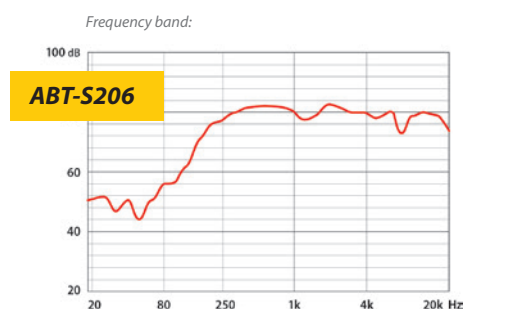
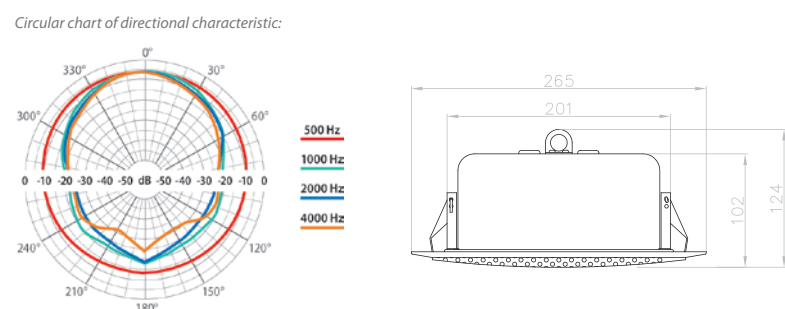
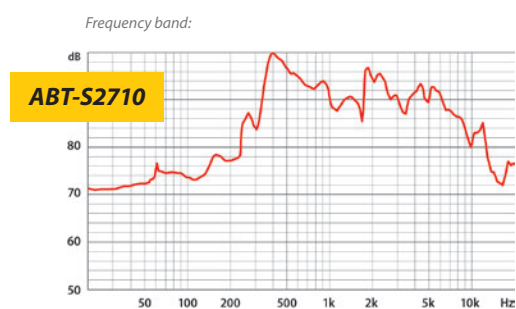
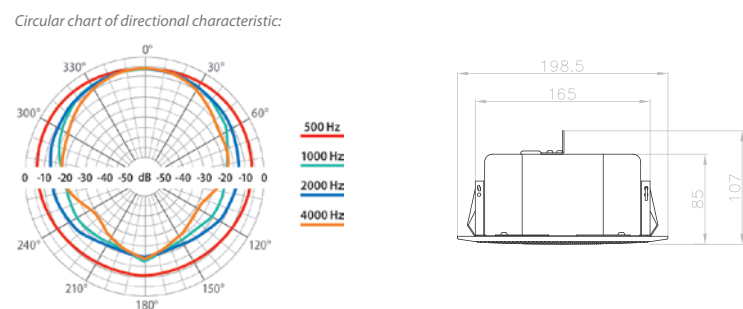
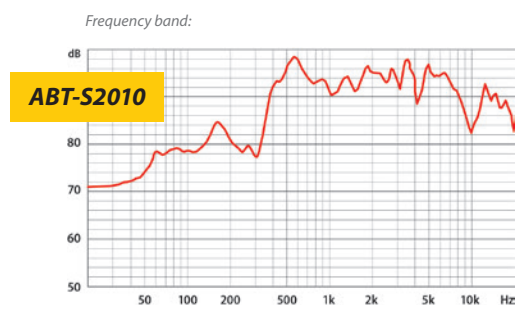
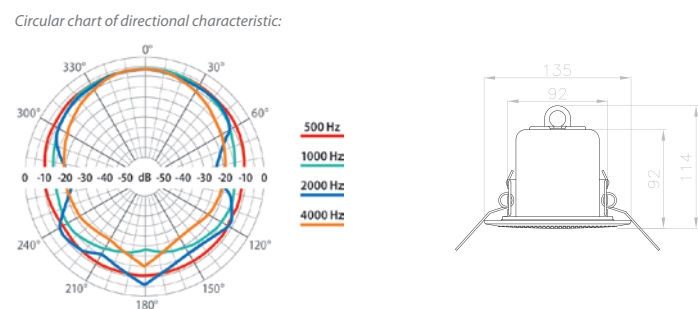
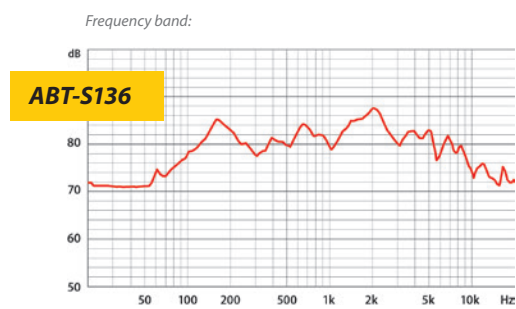
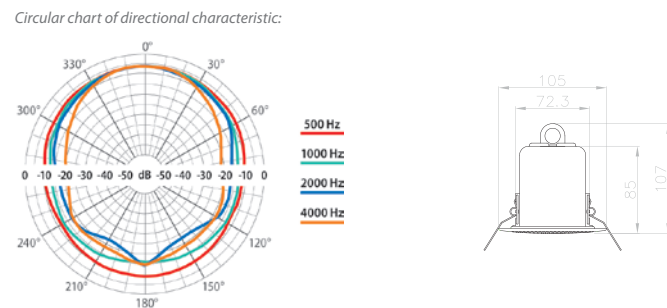
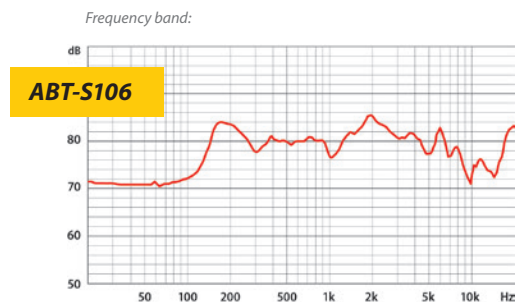

ABT-TNL100

Highly Directional Tunnel Loudspeaker

- ✓ Full compliance with EN 54-24 Standards
- ✓ Specially designed for tunnel applications
- ✓ Highly directional asymmetric horn
- ✓ Excellent speech intelligibility
- ✓ Stainless steel construction
- ✓ Waterproof housing IP66
- ✓ High power output 100/50 W



In case of an emergency, the Voice Evacuation System needs to guide people in the tunnel to safety so the audio transmission should be as clear as possible. In general, due to high levels of reverberation and noise, a tunnel is not an ideal environment for Voice Evacuation System and therefore speech intelligibility becomes a critical parameter for any voice alarm application. To establish

a sufficient level of speech intelligibility, a highly directional speakers system is required. By reducing the energy emitted to other surfaces, reflective sound energy can be minimized which results in a better direct to reverberant ratio. This will improve the maximum feasible speech intelligibility. To minimize disturbing echo effects, resulting in a loss of speech intelligibility, each horn

speaker is driven by an individual signal channel in a 100 V installation, which is equipped with audio DSP including EQ and delay. Our product S4T (Safety For Tunnel) offers the most effective solution which seamlessly combines a dedicated Voice Evacuation System with tailored Tunnel Loudspeakers.

	ABT-TNL100
Electrical	
Rated power, W	100
Tappings 100 V line, W	100 / 50
Transformer impedance, Ω 100V	100 / 200
Driver impedance, Ω	6
Effective frequency range, Hz	250-8000
Sensitivity @ 4 m, 1 W, dB	105
SPL @ 4 m, Rated power, dB	125
SPL @ 1 m, 1 W, dB	117
SPL @ 1 m, Rated power, dB	137
Dispersion, horizontal x vertical, [°]	25 x 35
Environmental	
Environmental type	B
IP Rating	IP66
Min / Max Amb Temp	-25°C / 70°C
Mechanical	
Dimensions, mm	1770 x 1020 x 455
Net Weight, kg	28
Colour	Grey (RAL 7035)
Material	Stainless steel
Mounting	Anchor for concrete
Option	
For DC line monitoring	Capacitor
Colour optional	RAL Palette

