



USER MANUAL

EN

Edition: 1 from 13.02.2023

Supersedes edition:

Power supplies HPSG3-LCD series

Switch mode power supply units with battery backup

Grade 3





GENERAL SAFETY RULES

Before installation, read the instruction manual to avoid errors that can damage the device and give you an electric shock.

- Before installation, cut off voltage in 230 V power-supply circuit.
- To switch power off, use an external switch, in which distance between contacts of all poles in disconnection state is not less than 3mm.
- The shock protection circuit shall be done with a particular care: the yellow and green wire coat of the power cable should be connected to the terminal marked with the grounding symbol on the PSU enclosure. Operation of the PSU without the properly made and fully operational shock protection circuit is **UNACCEPTABLE!** It can cause damage to the equipment or an electric shock.
- Device should be transported without batteries. This has a direct impact on safety of user and device.
- Installing and connecting power supply must be carried out without batteries.
- When connecting batteries to power supply, pay particular attention to correct polarity. If necessary, it is possible to permanently disconnect battery from power supply systems by removing F_{BAT} fuse.
- Power supply is adapted to be connected to a power distribution network with an effectively earthed neutral conductor.
- Ensure a free, convection air flow around the enclosure. Do not cover ventilation openings.

TABLE OF CONTENTS

1. FEATURES.....	5
2. TECHNICAL DESCRIPTION.	6
2.1 GENERAL DESCRIPTION.	6
2.2 BLOCK DIAGRAM.	7
2.3 DESCRIPTION OF COMPONENTS AND POWER SUPPLY TERMINALS.	8
3. INSTALLATION.....	10
3.1 REQUIREMENTS.	10
3.2 INSTALLATION PROCEDURE.	10
3.3 PROCEDURE FOR CHECKING POWER SUPPLY MODULE ON INSTALLATION SITE.	11
4. FUNCTIONS.....	12
4.1 TECHNICAL OUTPUTS.	12
4.2 COLLECTIVE FAILURE INPUT EXT IN.	13
4.3 OPTICAL INDICATION.	14
4.4 INDICATION OPENING ENCLOSURE - TAMPER.	14
4.5 PSU OVERLOAD.	14
5. RESERVE POWER SUPPLY CIRCUIT.	15
5.1 RUNNING PSU ON BATTERY BACKUP.	15
5.2 DEEP DISCHARGE BATTERY PROTECTION UVP.	15
5.3 BATTERY TEST.	15
5.4 MEASUREMENT OF RESISTANCE OF BATTERY CIRCUIT.	15
5.5 BATTERY OPERATING TEMPERATURE READINGS.	15
5.6 STANDBY TIME.	15
6. GRAPHIC LCD DISPLAY – PREVIEW 16	16
6.1 CONTROL PANEL.	16
6.2 FIRST RUN OF PSU – LANGUAGE SELECTION SCREEN.	16
6.3 MAIN SCREEN OF LCD.	17
6.4 INFORMATION DISPLAYED ON LCD PANEL.	17
6.4.1 <i>Preview menu.</i>	17
6.4.2 <i>LCD screen – current parameters</i> 	18
6.4.3 <i>LCD screen – current failures</i> 	19
6.4.4 <i>LCD screen – history of parameters</i> 	19
6.4.5 <i>List of failure codes and information messages.</i>	20
7. GRAPHIC LCD DISPLAY - PSU SETTINGS.....22	22
7.1 PASSWORD.....	22
7.1.1 <i>Entering the password.</i>	22
7.1.2 <i>Changing password.</i>	23
7.1.3 <i>Disabling the password.</i>	23
7.1.4 <i>Resetting passwords.</i>	23
7.1.5 <i>Password unlocking procedure.</i>	24
7.1.6 <i>Keyboard lock.</i>	24
7.2 PSU MENU.....	25
7.2.1 <i>Performing battery test.</i>	25
7.2.2 <i>Setting communication address.</i>	26
7.2.3 <i>Setting transmission parameters.</i>	27
7.3 CONTROL PANEL MENU.	28
7.3.1 <i>Setting display language.</i>	28
7.3.2 <i>Setting date.</i>	29
7.3.3 <i>Setting time.</i>	29
7.3.4 <i>Setting backlight mode.</i>	30
7.3.5 <i>Contrast setting.</i>	30
7.3.6 <i>Blinking light indicating failure</i>	31

8. REMOTE MONITORING (OPTION: ETHERNET, RS485).....	32
8.1 ETHERNET NETWORK COMMUNICATION.....	32
8.2 „POWERSECURITY” WEB APPLICATION.....	33
9. SPECIFICATIONS.	36
TABLE 12. ELECTRICAL PARAMETERS.....	36
TABLE 13. MECHANICAL PARAMETERS.....	37
TABLE 14. OPERATING PARAMETERS.	38
TABLE 15. OPERATION SAFETY.....	38
10. TECHNICAL INSPECTIONS AND MAINTENANCE.	39
10.1 BATTERY REPLACEMENT OF LCD PANEL.....	39

1. Features

- compliance with norm EN50131-6:2017 in grade 1, 2, 3 and II environmental class
- compliance with norm EN60839-11-2:2015+AC:2015 and I environmental class
- supply voltage ~200-240 V
- DC 13,8 V or 27,6 V uninterruptible power supply
- powered by **17Ah - 65Ah** batteries
- high efficiency (up to 86%)
- available versions with current efficiencies
13,8V: 3A, 5A, 10A
27,6V: 2A, 5A
- low ripple voltage
- microprocessor-based automation system
- measurement of resistance of battery circuit
- automatic temperature-compensated charging
- automatic battery test
- output voltage control
- battery circuit continuity control
- battery voltage control
- battery charging and maintenance control
- deep discharge battery protection (UVP)
- battery overcharge protection
- battery output protection against short circuit and reverse connection
- function START allows running PSU from battery power
- optical indication
- technical outputs OC type (open collector)
- collective failure input EXT IN
- EPS technical output indicating AC power loss
- PSU technical output indicating PSU failure
- APS technical output indicating battery failure
- protections:
 - SCP short circuit protection
 - OLP overload protection
 - OVP overvoltage protection
 - surge protection
- optional equipment (AWZ642)
- optical indication – LCD panel
 - electrical parameters' readings, e.g. voltage, current
 - failure indication
 - PSU settings adjusted from panel's level
 - 3 levels of access, password-protected
 - operation memory of PSU
 - failure memory
 - real-time clock, battery-backed
 - internal memory of PSU operating status
- remote monitoring
 - Ethernet or RS485 communication (options)
 - embedded PowerSecurity web application
 - preview of the operating parameters: voltages, currents, temperature and resistance of the battery circuit
 - PSU work history chart from a period of more than 100 days: voltages, currents and resistance of the battery circuit
 - battery operating temperature readings from period up to 5 years
 - event log of up to 2048 power supply failures
 - remote battery test
 - „SERIAL” communication port with implemented MODBUS RTU protocol
 - remote monitoring (options: Ethernet, RS485)
 - remote battery test (additional modules required)
- convectional cooling
- warranty - 3 years from production date

2. Technical description.

2.1 General description.

Buffer power supplies have been designed in accordance with requirements of the (I&HAS) EN50131-6:2017 grade 1-3 and II environmental class and (KD) EN60839-11-2:2015+AC:2015 standard and I environmental class. Power supplies units are intended for an uninterrupted supply of alarm system devices requiring stabilized voltage of 12 or 24 V DC ($\pm 15\%$).

Depending on a required protection level of the alarm system in the installation place, the PSU efficiency and the battery charging current should be set as follows:

Power supply model	Battery/charging current	Output current [A] depending on application PSU (according to EN50131-6)		
		Grade 1, 2 – standby time 12 h	* Grade 3 – standby time 30 h	** Grade 3 – standby time 60 h
HPSG3-12V3A-C-LCD	17Ah / 0,8 A	1,39 A	0,54 A	0,25 A
HPSG3-12V5A-C-LCD	17Ah / 0,8 A	1,39 A	0,54 A	0,25 A
HPSG3-12V5A-D-LCD	40Ah / 1,8 A	3,3 A	1,30 A	0,64 A
HPSG3-12V10A-E-LCD	65Ah / 2,6 A	5,4 A	2,1 A	1,0 A
HPSG3-24V2A-C-LCD	17Ah (x2) / 0,8 A	1,4 A	0,5 A	0,24 A
HPSG3-24V5A-D-LCD	40Ah (x2) / 1,8 A	3,3 A	1,3 A	0,63 A

* if faults of primary source are reported to the ARC alarm receiving centre (in accordance with 9.2 EN50131-6)

** if faults of primary source are not reported to the ARC alarm receiving centre (in accordance with 9.2 EN50131-6)

In case of lack of main power, battery back-up is activated immediately. Metallic enclosure with PSU (colour RAL 7016 - grey) can accommodate battery/batteries. It is equipped with a tamper switches signalling door opening and detaching from the surface.

2.2 Block diagram.

PSU has been manufactured based on a high-efficiency system of AC/DC converter. Applied microprocessor circuit is responsible for full diagnostics of PSU parameters and batteries.

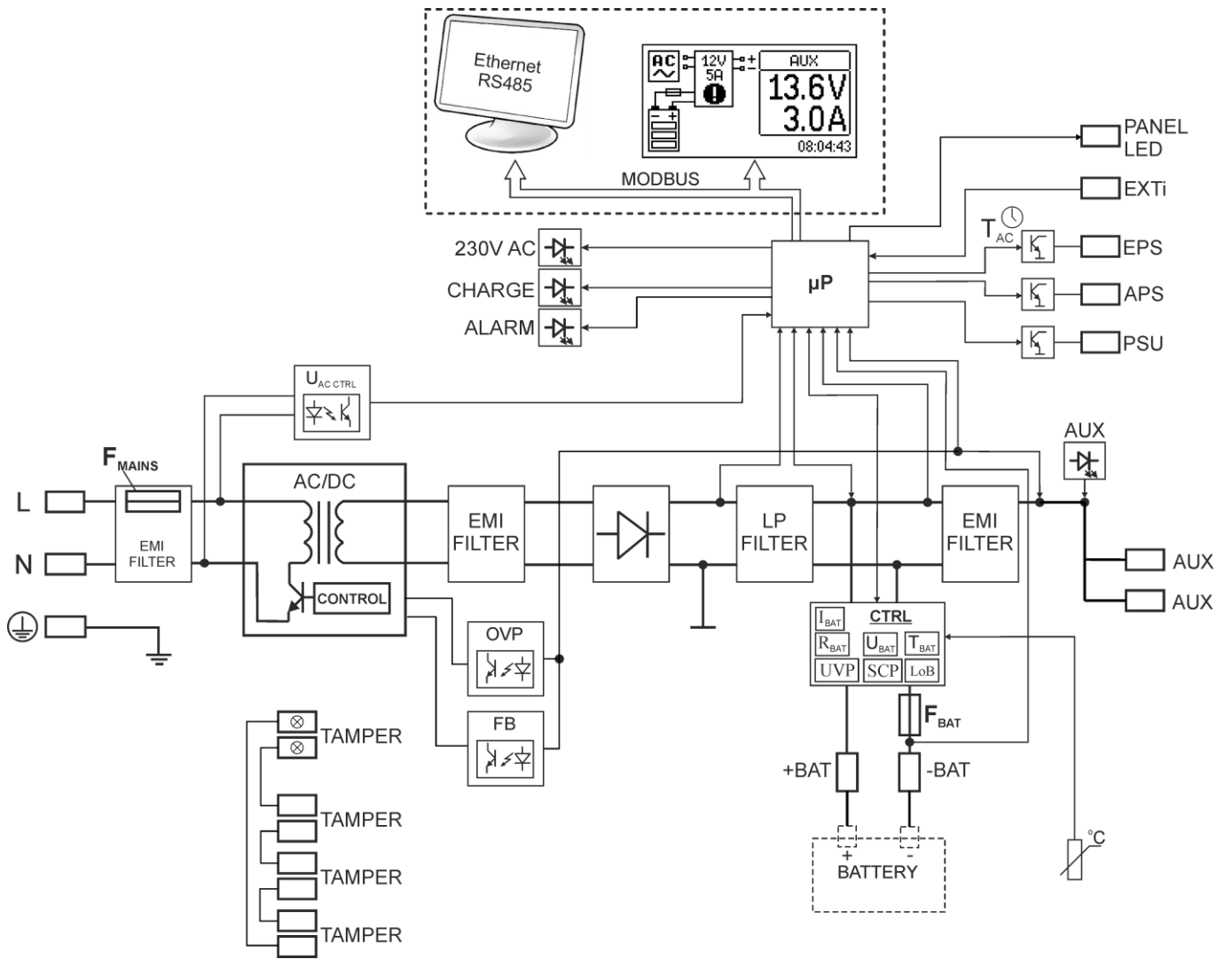

Fig. 1. Block diagram of PSU.

2.3 Description of components and power supply terminals.

Table 1. Elements of PSU PCB (Fig. 2).

Element no.	Description
1	230 V supply connector with a terminal for connection of a protective conductor
2	START – button (launching from battery)
3	Battery temperature sensor
4	START – button (launching from battery) Terminals: +AUX, -AUX – AUX power supply output (- AUX=GND, +AUX= power supply output) EPS – technical output of AC network absence indication - OC type Open = AC power failure Close = AC supply - O.K. APS – technical output of battery failure Open = battery failure Close = battery O.K. PSU – technical output of PSU failure - OC type Open = failure Close = O.K. EXTi – input of external failure. Closed input = no indication Open input = failure +BAT- – terminals for connecting the battery TAMPER – antisabotage protection microswitch connector TEMP – input of battery temperature sensor
5	Battery connectors ; positive: +BAT = red, negative: - BAT = black
6	PANEL – connector to external LED indicators
7	LEDs - optical indication: 230 V AC – indicates ~230 V power CHARGE – battery charging indication ALARM – collective fault indication
8	F_{BAT} – fuse in battery circuit
9	LCD connector
10	Communication interface connector

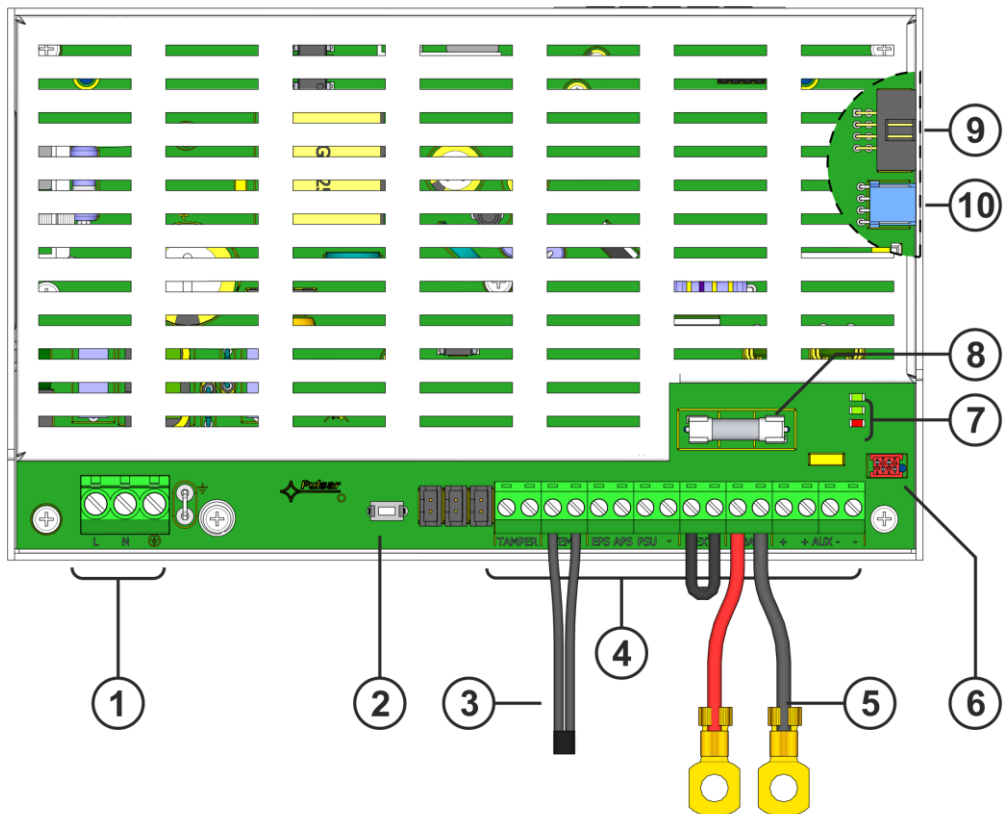

Fig. 2. View of power supply module.

Table 2. Elements of PSU (see Fig. 3).

Element no.	Description
①	PSU module (Tab. 1, Fig. 2)
②	Battery temperature sensor
③	Battery connectors; positive: BAT = red, negative: - BAT = black
④	A place for installation of additional communications modules
⑤	TAMPER; microswitch (contacts) of antisabotage protection (NC)
⑥	Fitting battery
⑦	Battery blocking plate
⑧	Screen module

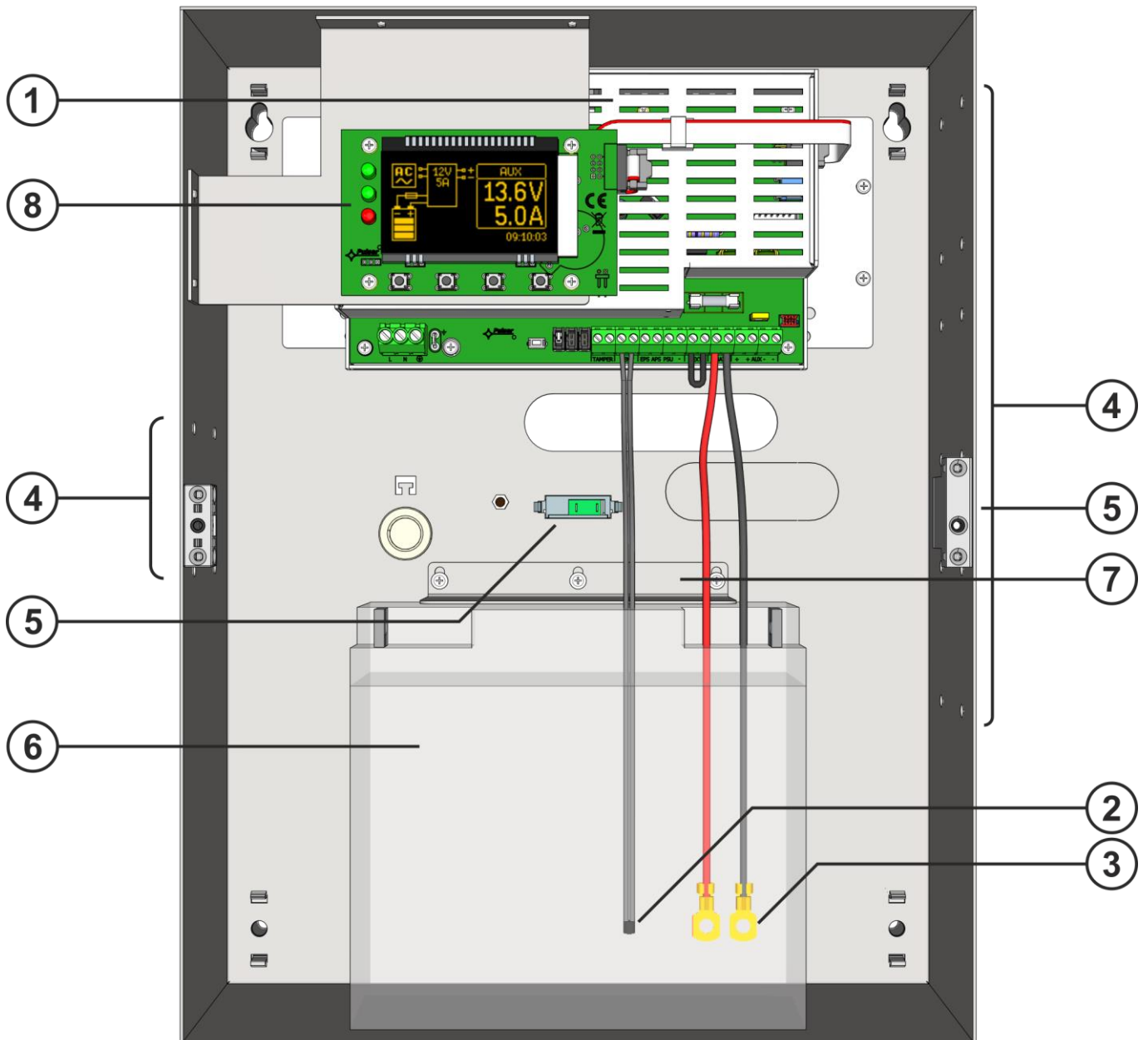

Fig. 3. View of PSU.

3. Installation.

3.1 Requirements.

Power supply units is to be mounted by a qualified installer, holding relevant permits and licenses (required in installation country) to connect (interfere) with ~230 V mains supply.

Because power supply units is designed for the continuous operation and is not equipped with ON/OFF switch, the power supply circuit should have the appropriate overload protection. Moreover, the user shall be informed about the method of unplugging (most frequently through separating and assigning an appropriate fuse in the fuse-box). The electrical system shall follow valid standards and regulations. The PSU shall work in a vertical position that guarantees sufficient convectional air-flow through ventilating holes of the enclosure.

As PSU cyclically runs a periodic battery test, during which resistance in battery circuit is measured, pay attention to proper connection of cables to terminals. Installation cables should be firmly connected to battery side terminals and to power supply connector. If necessary, it is possible to permanently disconnect battery from power supply systems by removing F_{BAT} fuse.



PSU is protected from access to configuration menu by two-level access passwords. If, during installation, modification of factory settings is required then access must be unlocked by entering the installer password - Table 9 and section 7.1.



3.2 Installation procedure.





CAUTION!

**Before installation, cut off voltage in ~230 V power-supply circuit.
To switch power off, use an external switch, in which distance between contacts of all poles in disconnection state is not less than 3mm.**

It is required to install in the supply circuits, in addition to power supply, circuit breaker with 6 A nominal current.

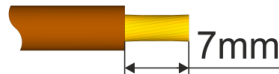
1. Mount the PSU in a selected location.
2. Connect power cables ~230 V to L-N clips of PSU. Connect ground wire to clip marked by earth symbol . Use a three-core cable (with a yellow and green protection wire ) to make connection. Wires should be deisolated to a length of 7mm.



Shock protection circuit shall be done with a particular care: yellow and green wire coat of power cable should be connected to terminal marked with grounding  symbol on PSU enclosure. Operation of PSU without properly made and fully operational shock protection circuit is UNACCEPTABLE! It can cause damage to equipment or an electric shock.

3. Connect receivers' cables to AUX output terminals.
4. If needed, connect cables from devices to technical inputs and outputs:
 - **APS**; technical output of battery failure
 - **EPS**; technical output indication of 230 V power collapse (alarm control panel, controller, indicator, etc.).
 - **PSU**; technical output of collective failure of PSU
 - **EXTi**; input of external failure
 - **TAMPER**; contacts of antisabotage protection
5. Install battery/batteries in a designated area of enclosure. Connect batteries with PSU paying special attention to correct polarity and type of connections (Fig. 4):



Fig. 4. Connecting batteries depending on voltage version of power supply:
 a) power supplies 12V version, b) power supplies 24V version

6. Screw terminals of temperature sensor to "Temp" terminals of PSU (figure 2, point 3). Attach sensor to battery, e.g. with adhesive tape. For the 27.6V version, it is recommended to place sensor between batteries.
7. Switch on ~230 V supply. The corresponding LEDs on the power supply PCB should be ON: green 230 V AC and above AUX connectors.
8. Check current consumption of receivers, taking into account battery charging current, so as not to exceed total current efficiency of PSU (see section 2.1).
9. Once the tests and control operation have been completed, close the enclosure.
10. Close the power supply cover after testing and operation control.

3.3 Procedure for checking power supply module on installation site.

1. Check indication displayed on printed circuit board of power supply:
 - a) 230 V AC LED should remain lit to indicate presence of mains supply voltage.
 - b) LED above AUX connectors lights up to indicate presence of output voltage.
2. Check output voltage after 230 V power failure.
 - a) Simulate lack of 230 V mains voltage by disconnecting main circuit breaker.
 - b) 230 V LED should go out.
 - c) LED above AUX connectors lights up to indicate presence of output voltage.
 - d) LED ALARM LED will start blinking.
 - e) EPS technical outputs will change status into opposite after time 11 s.
 - f) Turn on 230 V mains voltage again. Indication should return to initial status from point 1 after about 11 seconds.
3. Check whether lack of continuity in battery circuit is properly indicated.
 - a) During normal PSU operation (230 V mains voltage on), disconnect battery circuit by disconnecting F_{BAT} fuse.
 - b) Within 5 minutes PSU will start signalling a failure in battery circuit.
 - c) LED ALARM LED will start blinking. APS technical output will change status into opposite.
 - d) F_{BAT} fuse in battery circuit again.
 - e) Power supply should return to normal operation, indicating initial status, within 5 minutes after battery test is completed.

4. Functions

4.1 Technical outputs.

PSU module is equipped with indication outputs OC type changing status after a specified event:

- **EPS - output indicating 230 V power loss.**

Output indicates 230 V power loss. Under normal status – with 230 V supply on, output is closed. In case of power failure, PSU will switch output into open position after a time about 11 seconds.

- **APS - output indicating battery failure.**

The output indicates the PSU failure. Under normal status (during correct operation) the output is closed. In case of failure, the PSU will switch the output into the open position. Failure can be triggered by the following events:

- defective or low battery
- battery voltage below 23 V or 11,5 V (depending on voltage version of power supply) during battery operation
- battery fuse failure
- no continuity in the battery circuit

- **PSU - output indicating PSU failure.**

The output indicates the PSU failure. Under normal status (during correct operation) the output is closed. In case of PSU failure, it will switch into the open position. PSU failure can be caused by the following events:

- low U_{AUX} output voltage, less than 23 or 13 V – depending on voltage version of power supply
- high U_{AUX} output voltage, higher than 28,4 or 14,2 V – depending on voltage version of power supply
- exceeding power supply output current
- battery charging circuit failure
- internal damage of PSU
- activation of the EXT IN input
- to high battery temperature ($> 65^{\circ}\text{C}$)
- temperature sensor failure, $t < -20^{\circ}\text{C}$ or $t > 80^{\circ}\text{C}$

The power supply technical outputs are open collector (OC) type, as shown schematically below.

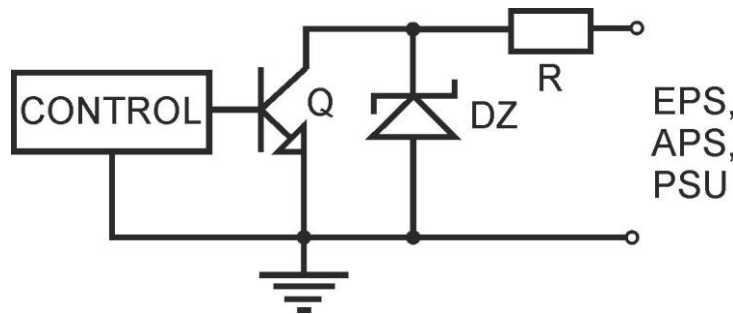

Fig. 5. Electrical diagram of technical outputs.

If it is necessary to use technical relay outputs, the AWZ642 relay module should be used.

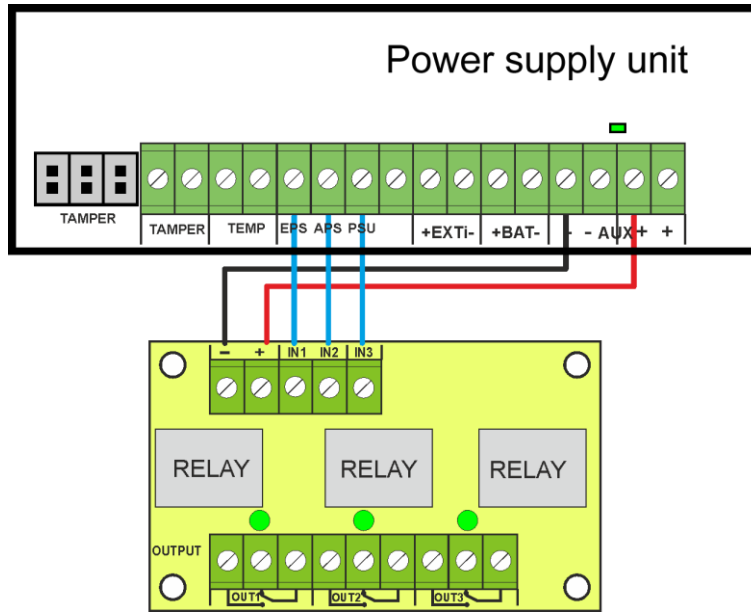

Fig. 6. Connection of the HPSG3 power supplies with the AWZ642 relay module.

4.2 Collective failure input EXT IN.

EXT IN (external input) technical input indicating collective failure is intended for additional, external devices that generate failure signal. The voltage appearing at the EXT IN input will trigger PSU failure, storing the information about the event in the internal memory and sending the signal about the failure to the PSU output.

The connection of external devices to the EXT IN input is shown in the electrical diagram below. OC outputs (open collector) or relay outputs can be used as the source of the signal.

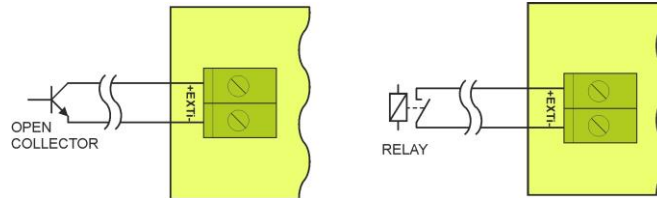

Fig. 7. Examples of connections.

The EXT IN input has been adjusted to work with fuse modules generating a failure signal in case of blown fuse in any of output sections (e.g. AWZ536). To guarantee a correct cooperation between the fuse module and the EXT IN input, the connections shall be made as presented in the diagram below.

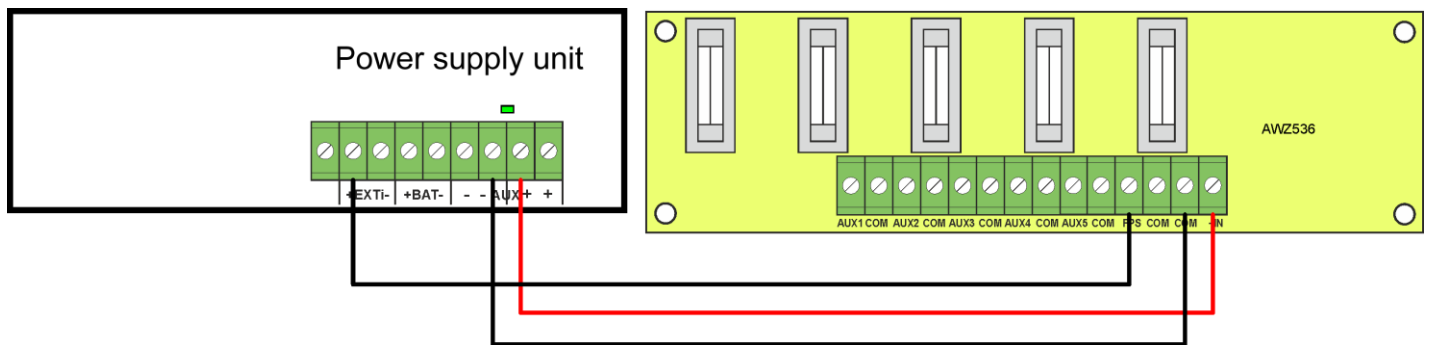





Fig. 8. Example of a connection with fuse module AWZ536

4.3 Optical indication.

PSU is equipped with LEDs on PCB indicating PSU operation status:

- 230V AC**  Indicating presence of ~230 V mains supply
- CHARGE**  Battery charging indication
- ALARM**  Collective fault indication

ALARM LED flashes specified number of times to indicate failure code according to table below. If PSU has several failures at the same time, they are all indicated consecutively.

Table 3. Coding of PSU failure by number of ALARM LED flashes on PCB of PSU.

Failure description	Number of flashes
F01 – AC power loss	1
F04 – Output overload	2
F05 – Undercharged battery	3
F06 – High AUX1 voltage	4
F08 – Charging circuit failure	5
F09 – Low AUX1 voltage	6
F10 – Low battery voltage	7
F12 – External input EXTi	8
F14 – Temperature sensor failure	9
F15 – High battery temperature	10
F16 – No battery	11
F17 – Battery fail	12
F30 – PSU overload	13
F51 – Service code	14
F52 F70 – Service codes	15



Failures are also indicated on the LCD panel (see section 6.4.3.)

4.4 Indication opening enclosure - TAMPER.

PSU is fitted with tamper microswitches indicating enclosure opening and detaching from surface.

Contacts of microswitches are normally closed, and their wires must be connected to input of control panel, etc.

4.5 PSU overload.

PSU is equipped with output overload protection circuit. If rated current of PSU is exceeded, microprocessor will switch to specially implemented procedure and signal failure on PSU output and ALARM LED on PCB. Depending on duration and level of PSU overload, microprocessor may put PSU into battery operation mode. After overload has stopped, PSU will resume correct operation.

An overload status of PSU is indicated by changing status of PSU technical output and blinking of ALARM LED on PCB.

5. Reserve power supply circuit.

PSU is fitted with circuits: charging and battery control whose main task is to monitor state of battery and connections in its circuit.

If controller detects a power failure in battery circuit, appropriate indication and change of APS technical output.

5.1 Running PSU on battery backup.

PSU has been fitted with a button on PCB to enable activate battery operation of PSU if required.

Activation of PSU from battery: to do that, press and hold the **START** button on the unit board for 1 second.

5.2 Deep discharge battery protection UVP.

PSU is fitted with disconnection system and battery discharge indication. During battery operation, lowering voltage below 10 V +/-0.2 V (20 V±0.2 in 27.6 V version) will disconnect battery within a few seconds.

Batteries are reconnected to power supply unit automatically once ~230 V mains supply is restored.

5.3 Battery test.

The PSU runs dynamic battery test every 5 minutes, temporarily switching the receivers to the battery operation mode. During testing, the control unit of the PSU measures the electrical parameters according to the implemented measuring method.

Negative test result will occur as soon as continuity of battery circuit is broken, or if voltage drops below 12 V or 24 V (depending on version of PSU).

Battery test function will also be automatically blocked if the PSU is in a working mode in which running of the battery test would not be possible. This condition occurs, for example, during battery operation or when PSU is overloaded.

5.4 Measurement of resistance of battery circuit.

PSU is checking resistance in battery circuit.

During measurement, PSU driver takes into account key parameters in circuit, and once limit value of 300m ohms is exceeded for 13,8 V version or 350 mΩ for 27,6 V version, a failure is indicated.

A failure may indicate considerable wear or loose cables connecting batteries.

5.5 Battery operating temperature readings.

Temperature measurement and compensation of battery charging voltage can extend life of batteries.

PSU has a temperature sensor to monitor temperature parameters of installed batteries. Attach sensor to battery, e.g. with adhesive tape. For the 27.6V version, it is recommended to place sensor between batteries. Be careful not to damage sensor when moving batteries.

5.6 Standby time.

Battery-assisted operating depends on battery capacity, charging level and load current. To maintain an appropriate standby time, current drawn from the PSU in battery mode should be limited.

Power supply model	Battery/charging current	Output current [A] depending on application PSU (according to EN50131-6)		
		Grade 1, 2 - standby time 12 h	* Grade 3 standby time 30 h	** Grade 3 standby time 60 h
HPSG3-12V3A-C-LCD	17Ah / 0,8 A	1,39 A	0,54 A	0,25 A
HPSG3-12V5A-C-LCD	17Ah / 0,8 A	1,39 A	0,54 A	0,25 A
HPSG3-12V5A-D-LCD	40Ah / 1,8 A	3,3 A	1,30 A	0,64 A
HPSG3-12V10A-E-LCD	65Ah / 2,6 A	5,4 A	2,1 A	1,0 A
HPSG3-24V2A-C-LCD	17Ah(x2) / 0,8 A	1,4 A	0,5 A	0,24 A
HPSG3-24V5A-D-LCD	40Ah(x2) / 1,8 A	3,3 A	1,3 A	0,63 A

* if faults of primary source are reported to the ARC alarm receiving centre (in accordance with 9.2 EN50131-6)

** if faults of primary source are not reported to the ARC alarm receiving centre (in accordance with 9.2 EN50131-6)

Depending on a required protection level of the alarm system in the installation place, the PSU efficiency and the battery charging current should be set as follows:

Output current PSU can be calculated from formula:

$$I_{WV} = Q_{AKU} / T - I_z$$

where:

Q_{AKU} – minimum battery capacity [Ah]

I_z – PSU current consumption (including optional modules) [A] (Table 4)

T- standby time (12, 30 or 60 h)

6. Graphic LCD display – preview

6.1 Control Panel.

The PSU features a panel with buttons and LCD display, enabling reading of all the available electrical parameters. The panel buttons are used to select and confirm the parameters, which should be displayed.

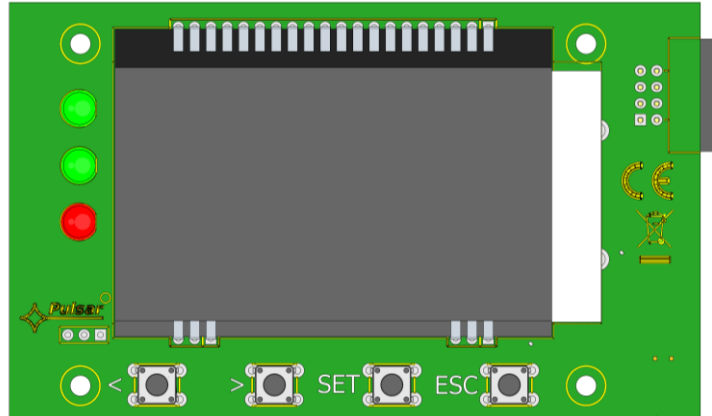

Fig. 9. Control Panel.

Table 4. Description of buttons and LEDs of LCD panel.

< >	- move cursor on display - next screen selection
SET	- selection approval
ESC	- leaving editing mode without changing values - selection approval
AC ●	- green LED indicating ~230 V power
AUX ●	- green LED indicating power at AUX output of PSU
ALARM ●	- red LED indicating PSU failure

6.2 First run of PSU – language selection screen.

One time, during the first run of the PSU, language selection screen will be displayed.

Use „<” or „>” buttons to select available languages. After selecting the appropriate language, confirm by pressing the "SET" button. The main screen will be displayed.



Fig. 10. Language selection screen.

If language selection is not done, language selection screen will be displayed on next start up. If choice has already been made, language selection can be done as explained in section 7.3.1.



To facilitate the user's selection of the language of messages, the PSU enables calling up a menu on the main screen, displaying all available languages. To this end, press the arrow keys “<” and “>” on the front panel of the PSU simultaneously and hold them for a minimum of 5 seconds.

6.3 Main screen of LCD.

Main screen of LCD displays basic electrical parameters and indicates current status of power supply.

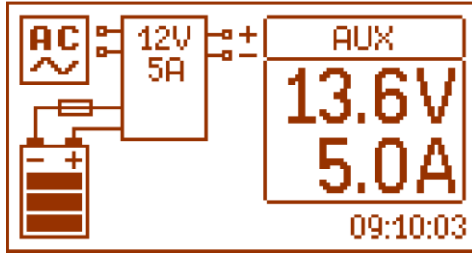

Fig. 11. Main screen of LCD.



The resolution of voltage and current measurement is 0.1 V and 0.1 A, respectively. The displayed values of voltages and currents should be treated with caution; if a greater accuracy is required, use a multi-meter.

Table 5. Description of main screen symbols.

Screen field	Operation status	Failure status
	indicating presence 230 V main voltage	Blinking AC icon
	Information about current voltage and power consumption at AUX output.	Parameter, which value has been exceeded, is blinking.
	Information about current state of battery charge	Blinking icon.
	Information about failure	Blinking warning symbol is displayed
	Information about failure on battery circuit	Blinking icon.
	Clock	

6.4 Information displayed on LCD panel.

6.4.1 Preview menu.

Pressing „ESC” button at bottom of display starts preview menu, allowing to choose one of four available PSU screens.

Use „<” or „>” buttons to choose a proper screen and press „SET” button to confirm.



- current parameters of PSU (see section 6.4.2)

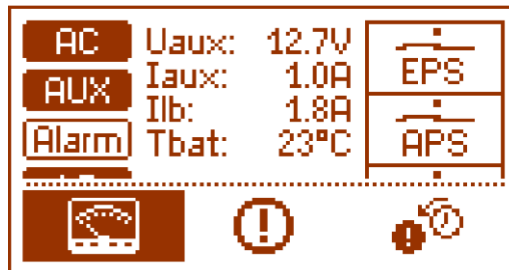



- current failures of PSU
(see section 6.4.3)

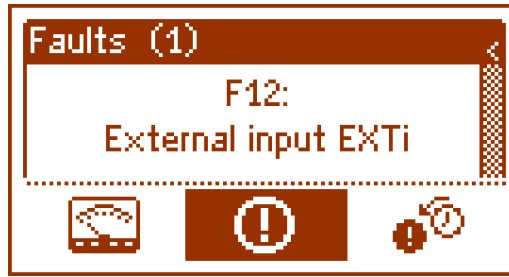

- event log
(see section 6.4.5)

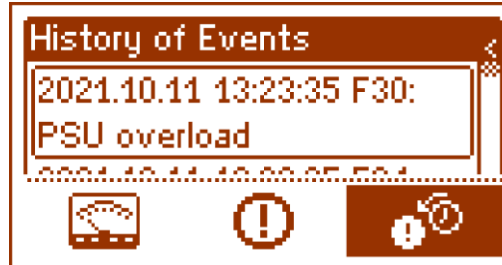

6.4.2 LCD screen – current parameters

To set screen, press „ESC” button, use „<” or „>” buttons to choose icon and press „SET” button to confirm.

Screen displays electrical parameters and status of technical outputs during operation. Illumination of an element informs about an activation and reflects status of LEDs on PCB of PSU (Table 1, [4]).

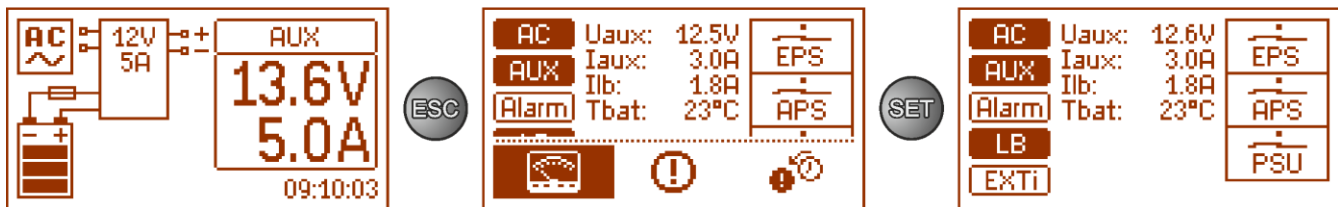



Fig. 12 LCD screen – current parameters.

Table 6. Description of screen symbols - current parameters of PSU.

Screen field	Description
	- Indicating presence of ~230 V voltage (highlighted = present mains supply ~230 V)
	- indication power at AUX output (highlighted = present voltage at AUX output)
	- Signal of a collective failure of the PSU (highlighted = failure)
	- Battery charging indication (highlighted = battery charging process)
	- EXTi input status indication (highlighted = EXTi input activated)
Uaux: 12.5V Iaux: 3.0A Iib: 1.8A Tbat: 23°C	Current electrical parameters of PSU: U_{AUX} – output voltage AUX I_{AUX} – output current AUX I_{LB} – battery charging current T_{bat} – battery temperature

	<p>Status of technical outputs:</p> <p>EPS – indicating presence of AC voltage open = AC power failure close = AC power – O.K.</p> <p>APS – battery failure indication open = battery failure close = battery O.K.</p> <p>PSU – PSU failure indication open = power supply failure close = PSU status O.K.</p>
---	---

6.4.3 LCD screen – current failures



In case of abnormal electrical parameters during the operation, the PSU will indicate a failure by displaying a message on the LCD, turning on the red LED **ALARM**  on the panel and changing the status of a dedicated technical output.



Fig. 13. Information that power supply is overloaded.

At a given time, multiple failures can occur. To check which faults are indicated, choose current failures of PSU screen.

To do that, press „ESC” button, use „<” or „>” buttons to choose icon  and press „SET” button to confirm.

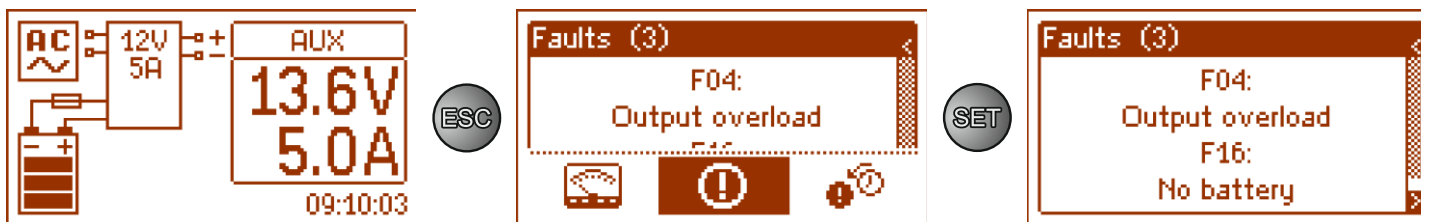



Fig. 14. LCD screen – current failures of PSU.

Screen displays codes and descriptions of failures. Display order of failures is arranged by priority of importance. First failures in display order are of highest priority.

6.4.4 LCD screen – history of parameters

If any incorrect electrical parameters occur during operation, PSU will start failure indication by displaying an appropriate message, cyclically blinking LCD display backlight, illuminating ALARM LED on panel and activating an acoustic indication (if it has not been switched off). The relevant technical outputs are also activated.

To choose history of events screen, press „ESC” button, use „<” or „>” buttons to choose icon  and press „SET” button to confirm.

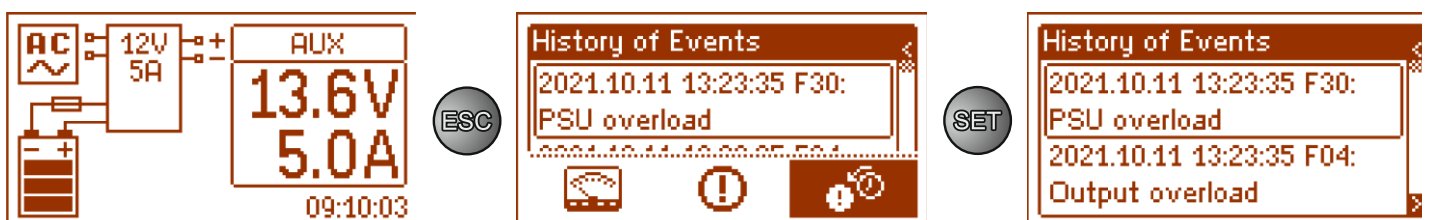

Fig. 15. History of events screen.

History of events screen enables overviewing events recorded by internal diagnostic system. Internal memory can store up to 2048 events, carrying information about fault type, time of occurrence and the values of other electrical parameters. In addition, the diagnostic system assigns the failure code for a particular event on the basis of the stored parameters.

In order to preview history of events, use „<” or „>” buttons. It can be done in two modes: short mode (date, time, code, fault description) or full mode - with additional information about electrical parameters and status of inputs and outputs. To switch between modes, press „SET” button.

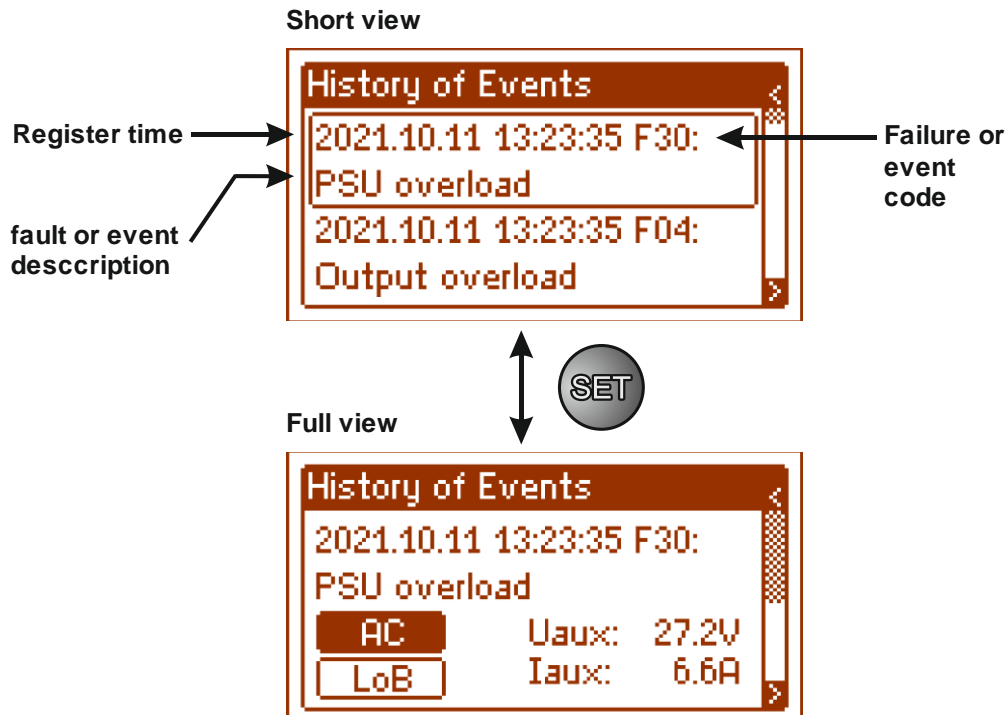

Fig. 16. Description of history of events screen.

Section 5.4.6 lists all codes that may occur during operation of PSU. Individual codes are accompanied by appropriate optical indication on panel, acoustic indication and activation of a dedicated technical output.



Memory of new power supply remembers events that are result of efficiency tests carried out at production stage.

6.4.5 List of failure codes and information messages.

PSU indicates operation status with appropriate code. Codes are divided into two groups, marked with initial letters „F” or „I”.

Codes beginning with letter „F” indicate a failure. Codes that begin with letter „I” indicate correct operation of PSU or repaired fault, involving, for example, fuse replacement: „I03 - BAT fuse replaced”.

Table 7. List of failure codes of power supply unit.

Failure code	Information	Technical output activation	Additional information
F01	AC power fail	EPS	- No AC mains supply - Burnt main fuse F _{MAINS}
F04	Output overload	PSU	- PSU overload
F05	Undercharged battery	APS	- Worn out battery - Undercharged batteries
F06	High AUX voltage	PSU	- Output voltage over 14,2 or 28.4V
F08	Charging circuit failure	PSU	- Battery charging circuit failure
F09	Low AUX voltage	PSU	- Output voltage below 13/26V
F10	Low battery voltage	APS	- The battery voltage has dropped below 11,5/ 23V (during battery operation)
F11	Low battery voltage – off	APS	- The battery voltage has dropped below 20V (during battery operation)

F12	External input EXTi	PSU	- Activation of the input of collective failure: EXTi
F14	temperature sensor failure	PSU	- Temperature sensor damaged - Temperature sensor disconnected
F15	High battery temperature	PSU	- The ambient temperature of the PSU is too hot - Batteries overloaded - Batteries damaged
F16	No battery	APS	- Batteries disconnected - Battery fuse damaged - Interruption on battery circuit
F17	Battery fail	APS	- Used battery - High inside resistance of battery
F30	PSU overload	PSU	- PSU overload
F64	Clock failure		- Check date and system time setting
F65	Access unlocked		- Access to PSU settings has been unlocked
F71	Low battery voltage RTC		- Discharged battery of LCD panel
F51-F74	Service codes	PSU	- Service codes

Table 8. List of PSU message codes.

Message code	Incident number	Description
I00	254	Power supply start-up
I01	253	AC power back
I05	249	Battery OK
I06	248	Battery temperature correct
I10	244	Battery test – start
I29	225	Power supply current exceeded
I30	224	Power supply current correct
I31	223	Charging

7. graphic LCD display - PSU settings

PSU has a configuration menu, allowing to configure PSU settings by changing or activating certain parameters. To enter setting mode, press „SET” button from main screen’s level.

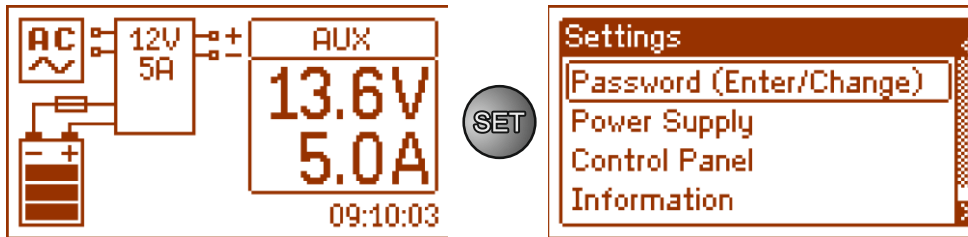

Fig. 17. PSU settings screen.

7.1 Password.

PSU supports two levels of access to configuration, which limit possibility of changing PSU’s settings from LCD panel. Both levels are protected by a separate password.

- Service password** – full access to PSU’s settings
- User’s password** – locked access to „PSU” settings menu

Table 9. Access ranges.

PASSWORD	Access range	
	„Control panel” settings	PSU settings
INSTALLER’S	•	•
USER’S	•	-



Pre-set passwords:

- User’s password** – 1111
- Service password** – 1234

7.1.1 Entering the password.

If access to configuration of power supply has been blocked by activation of service or user password, perform following steps in order to unlock PSU configuration:

- use „<” or „>” buttons to display menu **Password (enter/change)**

- press „SET” button, another window with available levels of passwords will be displayed

- use „<” or „>” buttons to choose right level of password

- confirm by pressing „SET” button

- use „<” or „>” buttons to enter first digit

- confirm by pressing „SET” button

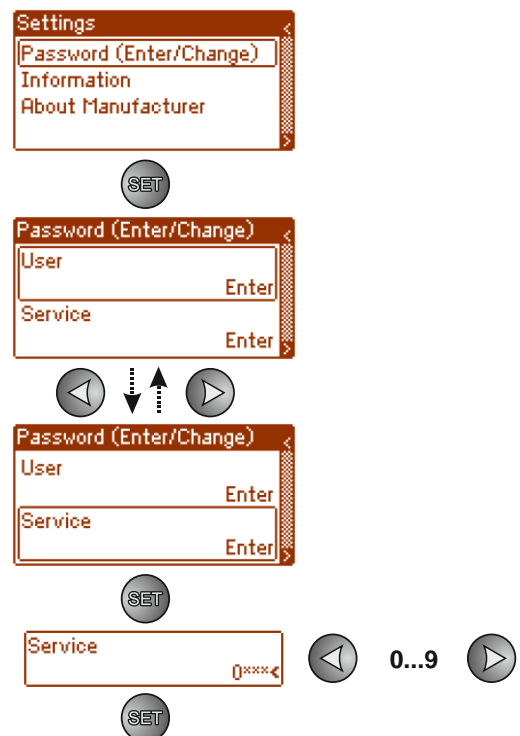

- use „<” or „>” buttons to enter second digit
- confirm by pressing „SET” button
- use „<” or „>” buttons to enter third digit
- confirm by pressing „SET” button
- use „<” or „>” buttons to enter fourth digit
- confirm by pressing „SET” button

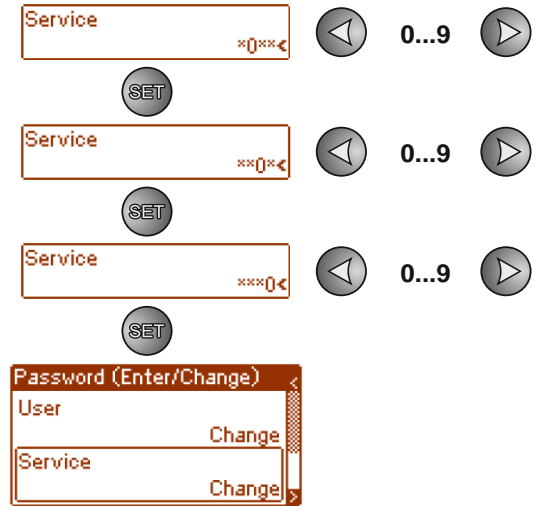

If entered password is wrong, following message will be displayed:

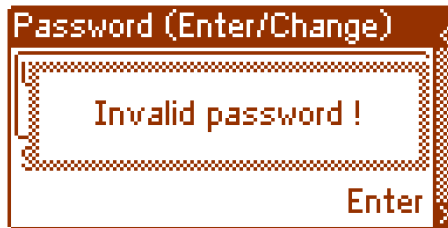

Fig. 18. Message after entering a wrong password.

After entering correct password, it is possible to access settings. If no buttons are pressed within 5 minutes, PSU settings will be locked automatically.

7.1.2 Changing password.

After entering correct password, it is possible to change it. To do this, choose a password that will be changed (user’s password or service password) and enter new one.

7.1.3 Disabling the password.

If password is not required, it can be turned off. Access to settings will not be locked after 5 minutes of inactivity. To disable password, type „0000” as a new password.

- User password „0000” unlocks access from user level.
- Service password „0000” unlocks access from installer level.

7.1.4 Resetting passwords.

If the passwords are lost for any reason, a procedure may be performed to enable the reassignment of the factory default passwords.

In order to perform this procedure, one should access the interior of the PSU casing. Locate the JP jumper in the rear part of the PCB of the LCD; it is used in the password unlocking procedure.

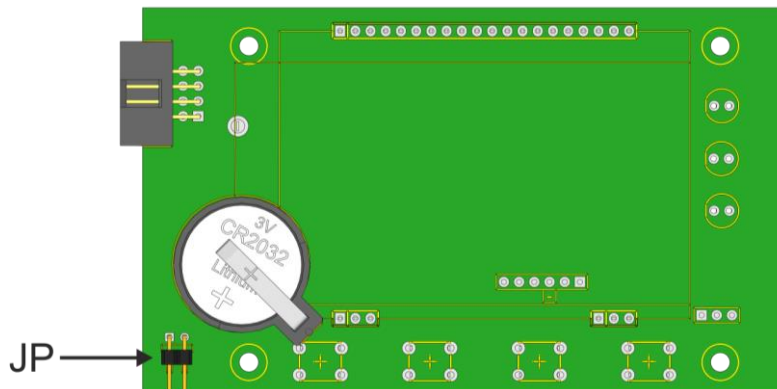

Fig. 19. Location of the JP jumper used in the password unlocking procedure.

7.1.5 Password unlocking procedure.

- Switch off the PSU completely for a minimum of 10 s. Disconnect the PSU both from the 230 V network and from the batteries.
- Place the JP jumper.
- Connect the batteries and switch on the 230 V network supply.
- Within 5 s from switching the PSU on, remove the JP jumper.
- The message „**Access unlocked**”, will appear on the display; confirm by pressing „SET”.
- Go to the menu „**Settings -> Password**” and replace the passwords with new ones.

7.1.6 Keyboard lock.

The PSU enables setting a key lock of the LCD panel.

The key lock function may only be selected if the installer password has been set. If the installer password is permanently unlocked with the „0000” code, the key lock option will not be available.

- use „<” or „>” buttons to display **Keyboard lock** menu

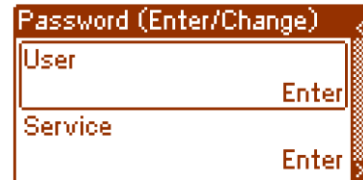

- use the „<” or „>” buttons to set the delay time



- use „<” or „>” buttons to select
YES – keyboard lock ON
NO – keyboard lock OFF



- confirm by pressing „SET” button



When on, keyboard will be locked automatically if no buttons are pressed within 5 minutes. After this time, pressing any button on control panel will display a window with keyboard password request. Enter password using „<” or „>” buttons as explained above.



Fig. 20. Keyboard password request.

Entering correct user's password unlocks access to settings from user level, while entering correct service password unlocks access to settings from installer level – full access.



If no buttons are pressed within 5 minutes, PSU settings will be locked automatically.

7.2 PSU menu.



„PSU” menu is only available after entering the correct service password.

Selecting „PSU” in settings menu will display another menu, allowing full configuration of PSU: ON/OFF battery protection, setting delay time for EPS output, communication parameters setting. After entering right settings, they are stored in internal non-volatile memory, which protects PSU against data loss in case of a failure or power failure.

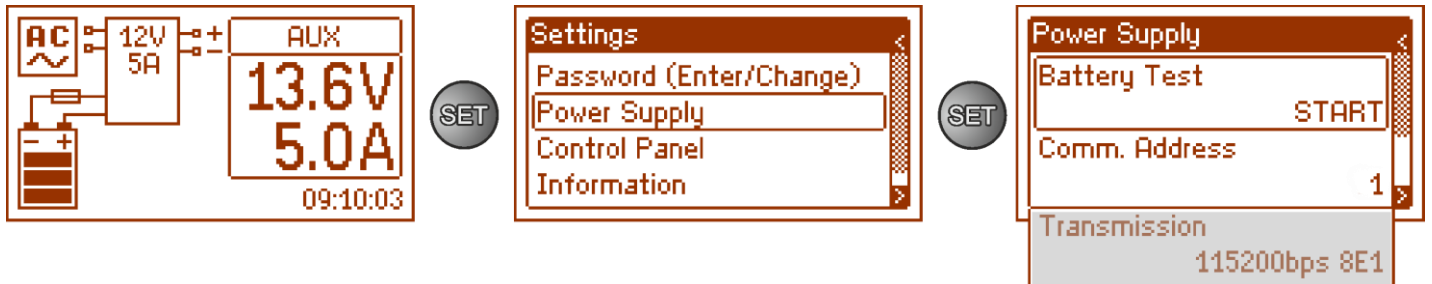

Fig. 21. „PSU” screen.

Table 10. Description of „PSU” screen.

Position	Description	Additional information
Battery test	START – manual activation of battery test	See section 7.2.1
Acoustic indication	1...247 PSU address required during communication with computer 1 – factory settings	See section 7.2.2
Transmission	Defines speed and protocol of communication 9.6k 8E1 (factory settings) 38.4k 8E1 115.2k 8E1	See section 7.2.3

7.2.1 Performing battery test.

The function enables testing of the batteries (see section 5.3) connected to the PSU. If the test result is negative, this will be signalled on the display by an appropriate message and change of the output status to ALARM.

- use the „<” or „>” buttons to display **Battery test** menu

- use the „<” or „>” buttons to set the delay time

- confirm by pressing „SET” button
(the battery test takes place immediately upon confirmation)

- During the test, the **WAIT** message appears on the screen

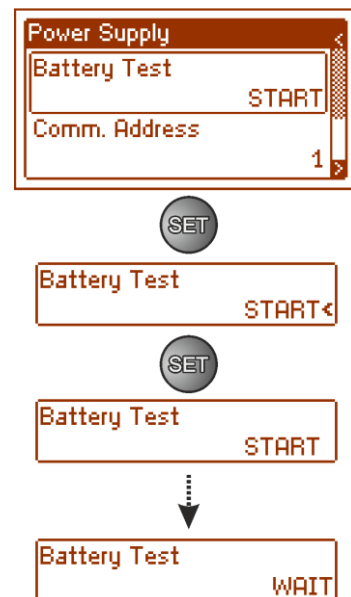

The PSU has a software protection against too frequent testing of batteries, which could cause them to undercharge. The protection consists in blocking the option of performance of the test for 60 s since it has last been enabled. In such situation, the “WAIT” message appears on the LCD in the Settings -> PSU -> Battery Test menu.

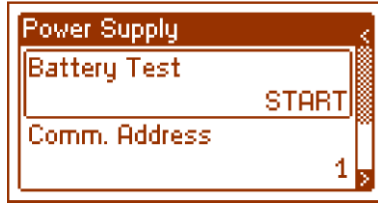

The temporary blockade option may be disabled through placing the JP jumper on the PCB panel of the display.

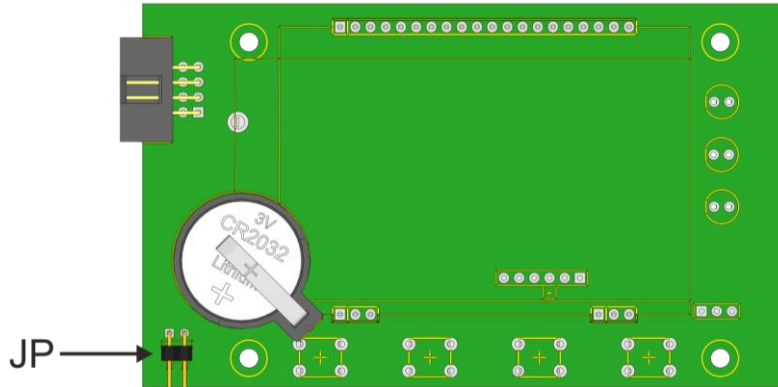

Fig. 22. Location of the JP jumper on the PCB panel of the display.

The battery test function will also be automatically blocked if the PSU is in a working mode in which running of the battery test would not be possible. Such a condition occurs e.g. during battery-mode operation. In such situation, the LCD shows the message „PROHIBITED” in the Settings -> PSU -> Battery Test menu.

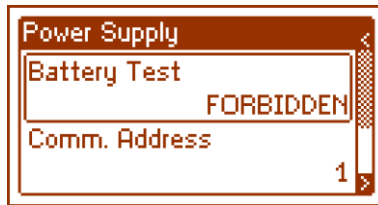

Fig. 23. Battery test – „PROHIBITED”.

7.2.2 Setting communication address.



All power supplies are factory-set to address 1.

- use „<” or „>” buttons to display **Communication address** menu

- use the „<” or „>” buttons to set the delay time

- use „<” or „>” buttons to set communication address
1...247 – PSU address during communication with computer

- confirm by pressing „SET” button

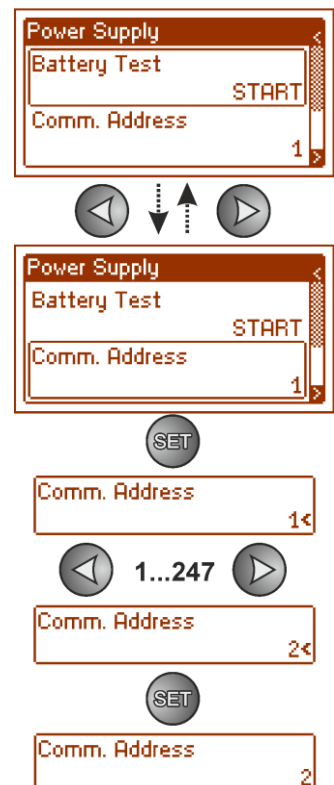

7.2.3 Setting transmission parameters.

Power supply has set transmission parameters of 9600 bps 8E1. However, if it is to be connected to a network with differently defined parameters, its configuration must be changed accordingly.

- use „<” or „>” buttons to display **Transmission** menu

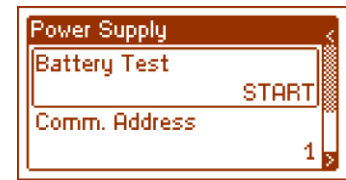

- use the „<” or „>” buttons to set the delay time



- use „<” or „>” buttons to set transmission speed

- **9.6k 8E1 (factory settings)**

- **38.4k 8E1**

- **115.2k 8E1**

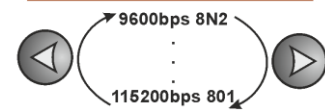

- confirm by pressing „SET” button



7.3 Control Panel menu.



Menu is only available after entering correct user's or service password.

The „control panel” menu enables configuration of the settings directly related to the user interface. It is possible to set the display language, date, time, intensity of the backlight and blinking light indicating failure.

Setting the correct date and time is important for keeping chronology of events stored in the internal memory. Setting the backlight mode and contrast guarantees the quality of the displayed messages. Intensity of LCD backlight can be set in range from 0 to 100%, in 10% intervals. Display features a function of constant or temporary backlight mode. In temporary mode, screen will turn off if no buttons are pressed within 5 minutes.

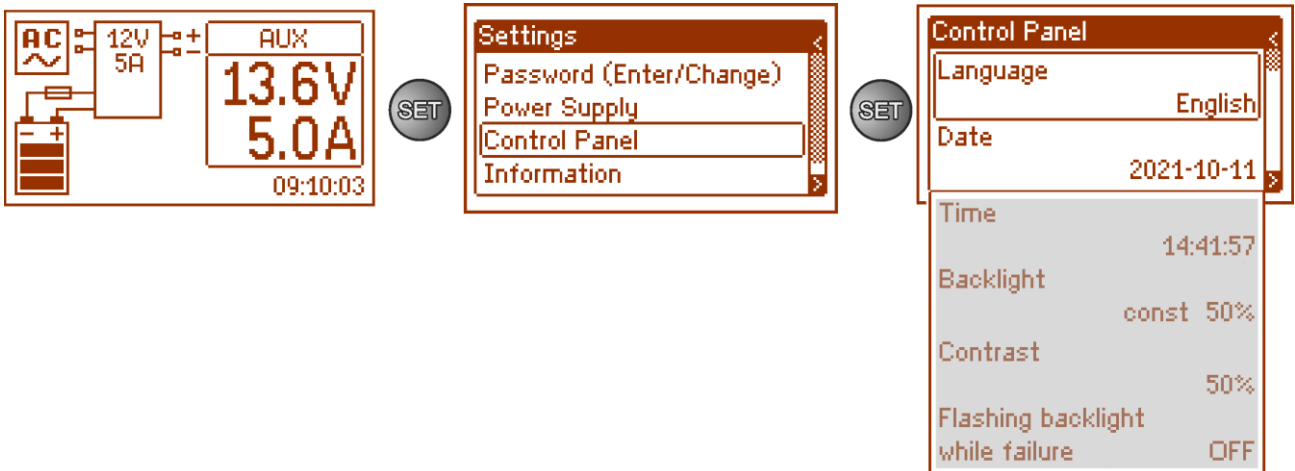

Fig. 24. „Control panel” screen.

Table 11. Description of „Control panel” screen.

Position	Description
Language	Available languages
Date	Current date
Time	Current time
Backlight	5 min - backlight mode OFF if no buttons are pressed within 5 min constant - backlight will not be turned off 0-100% - intensity of backlight
Contrast	0-100% - display contrast
Blinking light indicating failure	YES – blinking light indicating failure OFF – constant light indicating failure

7.3.1 Setting display language.

One of functions of control panel menu is possibility to select language. Display language can be set according to personal preference.

- use „<” or „>” buttons to display **Language** menu

- use the „<” or „>” buttons to set the delay time

- use „<” or „>” buttons to choose display language

- confirm by pressing „SET” button

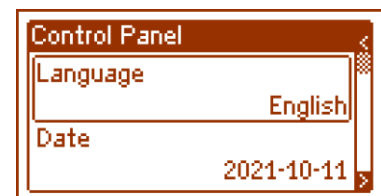

7.3.2 Setting date.

„Date” menu in „Control panel” menu enables setting correct date, according to which error messages and operation history will be saved. Built-in real time clock does not take into account leap years and changes resulting from switch between summer and winter time. These changes should be taken into account when analyzing events recorded in history.

- use „<” or „>” buttons to display **Date** menu

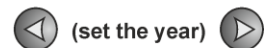
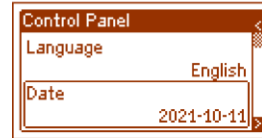
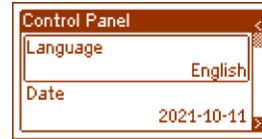

- press „SET” button, prompt will appear next to year digits
- use „<” or „>” buttons to set year
- press „SET” button, prompt will appear next to month position
- use „<” or „>” buttons to set current month
- press „SET” button, prompt will appear next to day position
- use „<” or „>” buttons to set current day
- confirm by pressing „SET” button

7.3.3 Setting time.

„Time” menu in „Control panel” menu enables setting correct time, according to which error messages and operation history will be saved. Built-in real time clock does not take into account leap year and changes resulting from switch between summer and winter time. These changes should be taken into account when analyzing events recorded in history.

- use „<” or „>” buttons to display **Time** menu

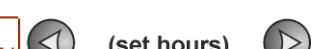
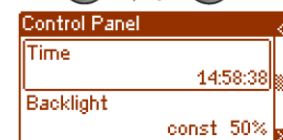
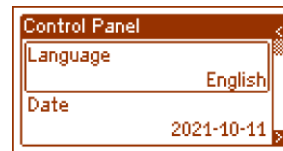

- press „SET” button, prompt will appear next to hour digits
 - use „<” or „>” buttons to set hour
 - press „SET” button, prompt will appear next to minute position
 - use „<” or „>” buttons to set minutes
 - press „SET” button, prompt will appear next to seconds' position
 - use „<” or „>” buttons to set seconds
- confirm by pressing „SET” button

7.3.4 Setting backlight mode.

„Backlight” menu dims display if no buttons are pressed within 5 min and sets intensity of backlight.

- use „<” or „>” buttons to display **Backlight mode** menu
- press „SET” button, prompt will appear next to **constant<** option
- use „<” or „>” buttons to change setting to **5 min**
- press „SET” button, prompt will appear at end of line
- use „<” or „>” buttons to set required brightness
- confirm by pressing „SET” button

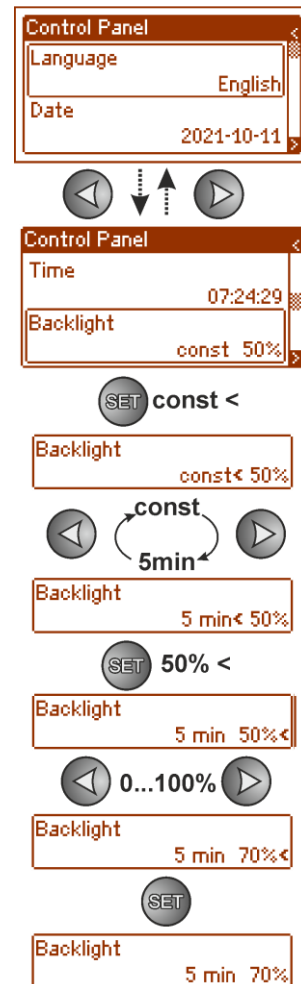

7.3.5 Contrast setting.

„Contrast” menu in „Control panel” enables setting contrast of display text.

- use „<” or „>” buttons to display **Contrast** menu
- use the „<” or „>” buttons to set the delay time
- use „<” or „>” buttons to set contrast
- confirm by pressing „SET” button

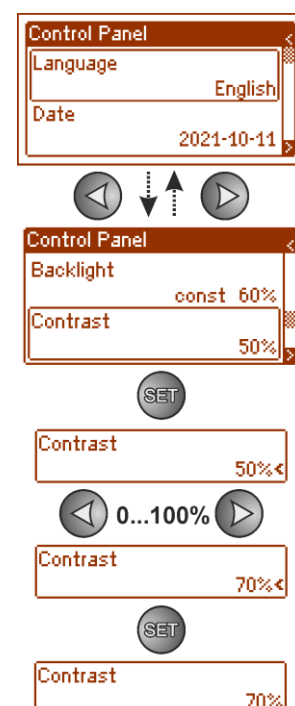

7.3.6 Blinking light indicating failure

„Blinking light indicating failure” menu enables setting backlight mode during failure indication. When on, blinking light will indicate a failure.

- use „<” or „>” buttons to display **Blinking light indicating failure** menu

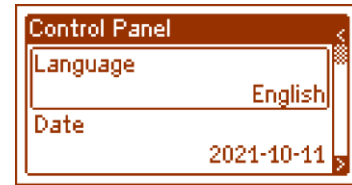

- use the „<” or „>” buttons to set the delay time

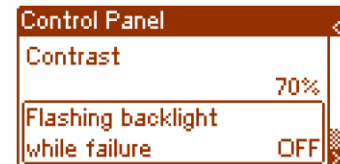

- use „<” or „>” buttons to select
YES – blinking light indicating failure ON
OFF – blinking light indicating failure OFF

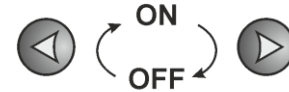

- confirm by pressing „SET” button



8. Remote monitoring (option: Ethernet, RS485).

PSU has been adjusted to operate in a system that requires a remote control of parameters in a monitoring centre. Transmitting information about the status of the PSU is possible by using an additional, external communication module realising communication in the Ethernet or RS485 standard.

The various connection topologies presented in the following section constitute only a part of the possible communication schemes. More examples can be found in the manuals dedicated to the individual interfaces.



When installing optional features in power supply unit, power supply current consumption, used for calculation of standby time, should be taken into account (see section. 5.6).

8.1 ETHERNET network communication.

Communication in Ethernet network is possible due to additional interfaces: Ethernet „INTE-C” and RS485-ETH „INTRE-C”, according to IEEE802.3 standard.

Ethernet „INTE-C” interface features full galvanic isolation and protection against surges. It should be mounted inside enclosure of PSU.

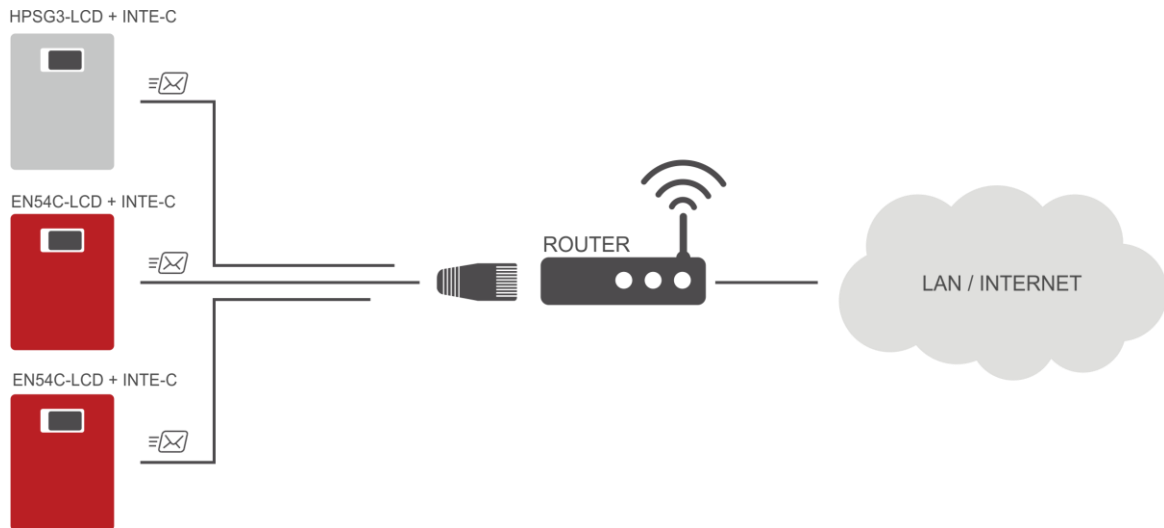

Fig. 25. Ethernet network communication using Ethernet „INTE-C” interface.

RS485-ETHERNET „INTRE-C” interface is a device used to convert signals between RS485 bus and Ethernet network. For proper operation, unit requires an external power supply in range of 10-30 V DC e.g. drawn from a PSU of HPSG3 series. Unit is mounted in a hermetic enclosure protecting against adverse environmental conditions.

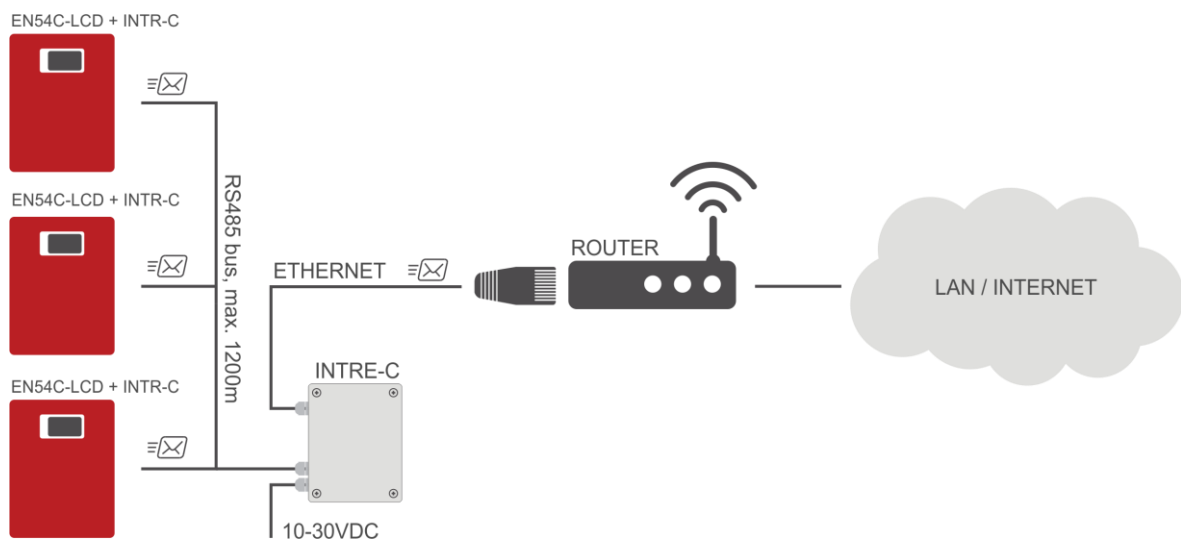

Fig. 26. Ethernet network communication using „INTR-C” and „INTRE-C” interfaces.

8.2 „PowerSecurity” web application.

The PowerSecurity web application has been embedded in the INTE-C and INTRE-C communication interfaces. The programme is a website uploaded from an embedded WWW server which is loaded upon entering the IP address in the web browser window.

Upon loading the PowerSecurity application, access is gained to the preview of the status of the PSU connected with an INTE-C interface, or to the preview of all PSUs in the RS485 bus in case of an INTRE-C interface.

From the WWW browser level, the current status of the PSU can be checked, with preview of such parameters as output voltages, presence of 230 V supply, or resistance of the battery circuit. Moreover, the application has an option of interface configuration for the function of remote alerting through email notification including information on the status of the PSU in case of occurrence of specific events.

The drawing below shows the appearance of a tab with the current PSU status.

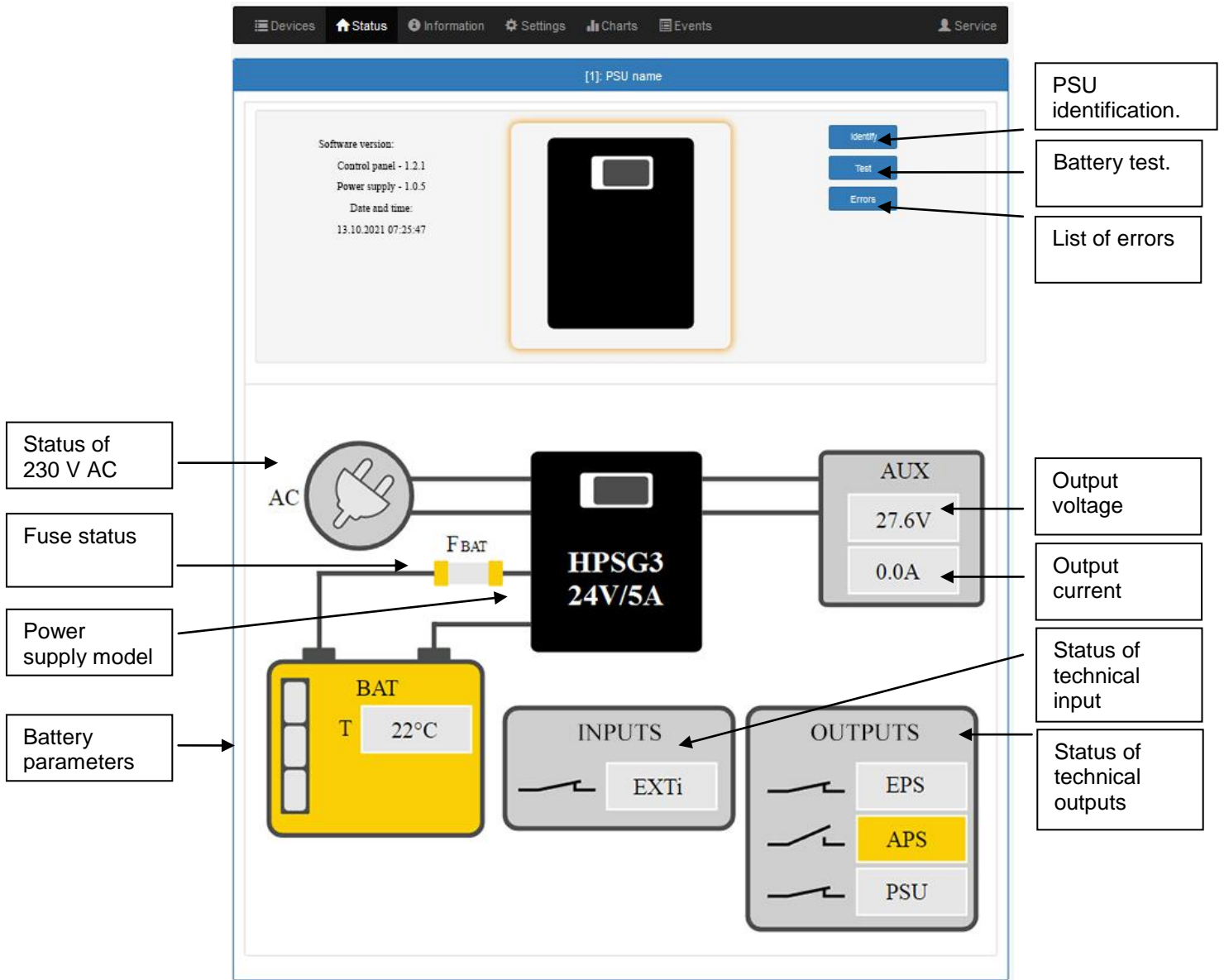

Fig. 27. View of the PSU status.

The web application also has a graphic tab „Graphs” from which the PSU history of operation may be downloaded and viewed in the graphic form, as a graph. A read graph may be saved in a file on a disc.

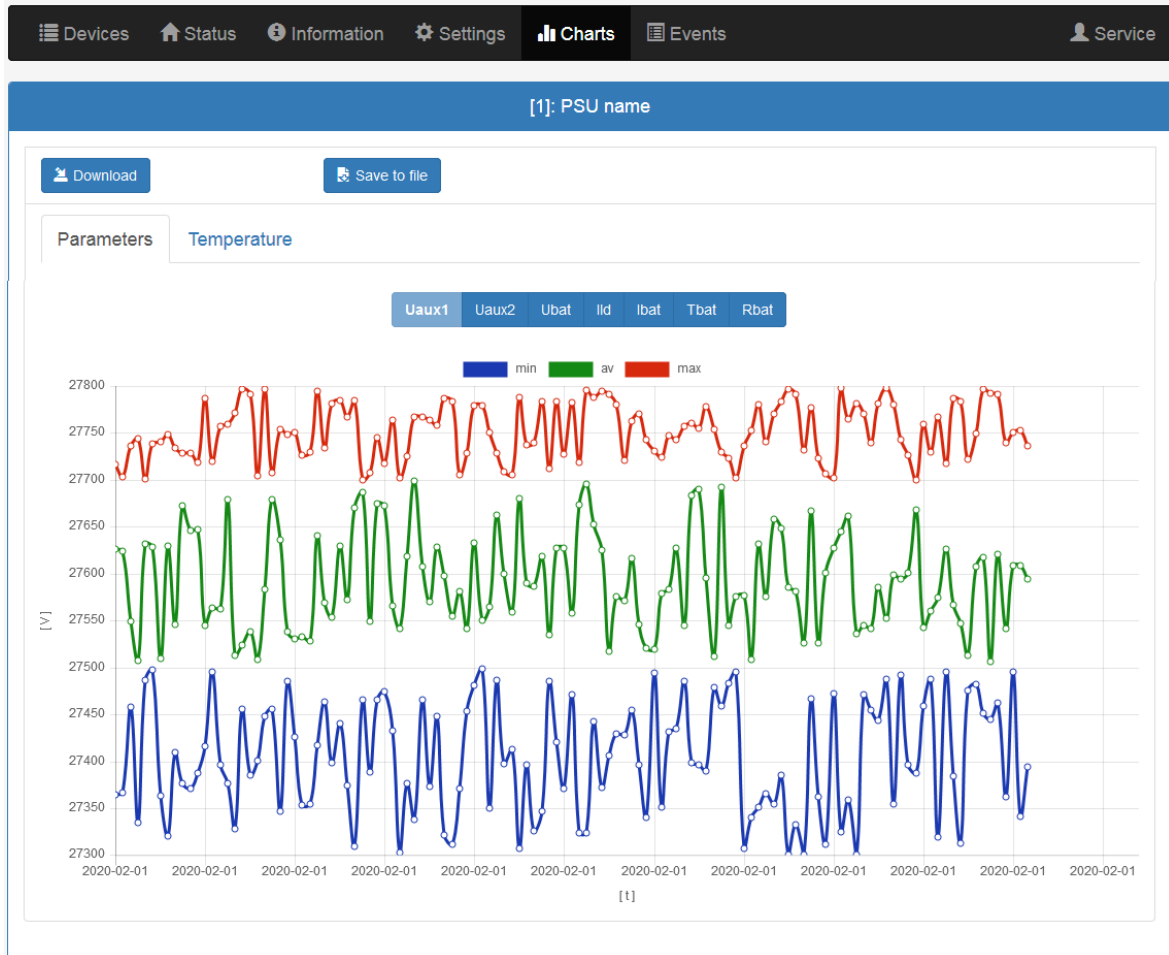

Fig. 28. View of the history of operation of PSU.

Another tab enabling checking of the PSU history is the tab of events. The read history is displayed as a table, following a chronological order. From the table, we can read the exact time of occurrence of the event, the error code, the event type description, as well as electric parameters and the status of individual technical outputs.

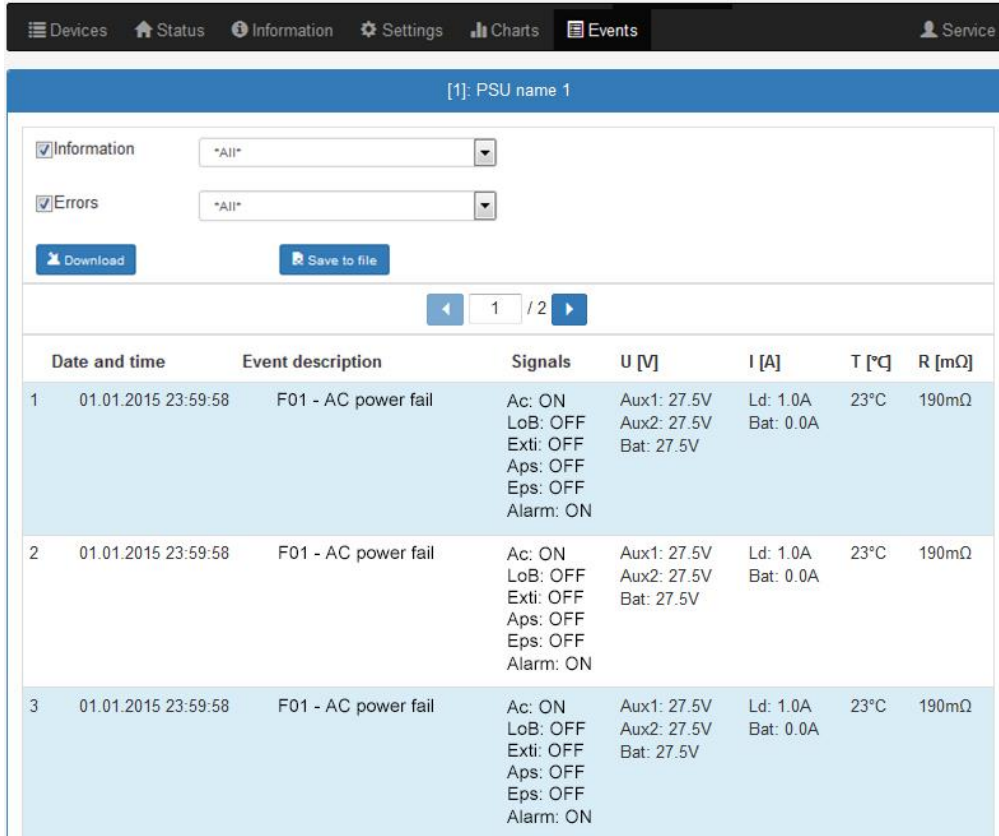

Fig. 29. View of the history of events.

The PowerSecurity programme provides functionality in the form of a remote battery test and the function of remote alerting via automatically sent email notifications. The notifications contain information on the current error codes, with the exact malfunction occurrence time.

The email notifications are sent to 2 recipients. The service includes SSL encryption of the mail and authorization for the user's verification through the outgoing mail system (SMTP) in order to ensure safety of the mail account.

Time periods between alerts and types of initiating events are individually configured by user.

9. Specifications.

Electrical parameters (tab. 12).

Mechanical parameters (tab. 13).

Operation safety (tab. 14).

Table 12. Electrical parameters.

	HPSG3-12V3A-C-LCD	HPSG3-12V5A-C LCD	HPSG3-12V5A-D LCD	HPSG3-12V10A-E LCD	HPSG3-24V2A-C LCD	HPSG3-24V5A-D LCD
PSU type EN 50131-6	A, degree of protection 1 – 3, II environmental class					
Supply voltage	~200-240 V					
Power frequency	50/60 Hz					
Current consumption	0,52 A	0,77 A		1,33 A	0,71 A	1,32 A
Output power PSU	48 W	76 W		138 W	69 W	138 W
Efficiency	81%	82%		85%	83%	86%
Output voltage at 20 °C	11 V-13,8 V DC – buffer operation 10 V-13,8 V DC – battery-assisted operation			22 V-27,6 V DC – buffer operation 20 V-27,6 V DC – battery-assisted operation		
Total output current with charging	3,5 A	5,5 A	5,5 A	10 A	2,5 A	5 A
Output current	2,7A	4,7A	3,7A	7,4A	1,7A	3,2A
Battery capacity	17.. 20 Ah	17.. 20 Ah	40.. 45 Ah	65 Ah	17..20 Ah	40.. 45 Ah
Battery charging current	0,8 A	0,8 A	1,8 A	2,6 A	0,8 A	1,8 A
Ripple voltage	50 mV p-p	50 mV p-p	50 mV p-p	80 mV p-p	50 mV p-p	50 mV p-p
Current consumption by PSU during battery-assisted operation	45 mA	45 mA	45 mA	45 mA	55 mA	55 mA
Coefficient of temperature compensation of battery voltage	-18 mV/ °C (-5°C-40°C)			-36 mV/ °C (-5°C-40°C)		
Low battery voltage indication	U _{bat} < 11,5 V, during battery operation			U _{bat} < 23 V, during battery operation		
Over voltage protection OVP	U > 16 V ± 1 V, automatic recovery			U > 32 V ± 2 V, automatic recovery		
Short-circuit protection SCP	Glass fuse F _{BAT} (in case of a failure, fuse-element replacement required)					
Overload protection OLP	105-150% PSU power, automatically recovered					

Battery circuit protection SCP and reverse polarity connection	Glass fuse F_{BAT} (in case of a failure, fuse-element replacement required)					
Deep discharge protection UVP	10 V +/- 0,3 V			20 V +/- 0,6 V		
Technical outputs: - EPS; output indicating AC power failure	- OC type: 50 mA max. normal status: L (0 V) level, failure: hi-Z level, time lag: 11 s.					
Technical outputs: - APS; output indicating battery failure - PSU; output indicating PSU failure	- OC type: 50 mA max. normal status: L (0 V) level, failure: hi-Z level.					
Technical outputs: - EXTi; input of external failure	Closed input – no indication Open input – alarm					
LCD screen battery	3V, lithium, CR2032					
Fuse F_{BAT}	F5A/250V	T6,3A/250V	T6,3A/250V	T10A/30V	F4A/250V	T5A/30V

Table 13. Mechanical parameters.

	HPSG3-12V3A-C-LCD	HPSG3-12V5A-C-LCD	HPSG3-12V5A-D-LCD	HPSG3-12V10A-E-LCD	HPSG3-24V2A-C-LCD	HPSG3-24V5A-D-LCD
Enclosure dimensions (WxHxD) [± 2 mm]	314x408x110	314x408x110	314x408x190	414x407x190	314x408x190	414x408x190
Fixing (WxH)	277x355	277x355	277x355	377x355	277x355	377x355
Space for battery (WxHxD)	304x166x94	304x166x94	304x172x172	404x178x172	304x172x172	404x178x172
Net/gross weight [kg]	6,4/6,7	6,5/6,9	8,6/9,1	11,2/11,8	8,6/9,1	11,2/11,8
Terminals	Battery outputs BAT: $\Phi 6$ (M6-0-2,5)					
	Mains supply: $\Phi 0,41-2,59$ (AWG 26-10), 0,5-4mm ² Outputs: $\Phi 0,51-2,05$ (AWG 24-12), 0,5-2,5mm ²					
Notes	Convictional cooling					

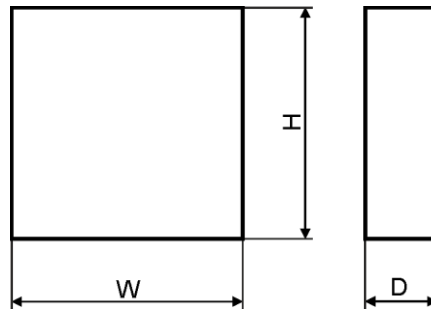

Fig. 30. Dimensions power supply.

Table 14. Operating parameters.

Environmental Class EN 50131-6	II
Environmental Class EN 60839-11	I (first)
Operating temperature	-10°C...+40°C
Storage temperature	-20°C...+60°C
Relative humidity	20%...90%, without condensation
Sinusoidal vibrations during operation:	According to EN 50130-5
Impulse waves during operation	According to EN 50130-5
Direct insolation	unacceptable
Vibrations and impulse waves during transport	According to PN-83/T-42106

Table 15. Operation safety.

Protection class EN 62368-1	I (first)
Protection grade EN 60529	IP44
Electrical strength of insulation: - between input and output circuits of PSU - between input circuit and protection circuit - between input circuit and output or protection circuit	4000 V DC 2500 V DC 500 V DC
Insulation resistance: - between input circuit and output or protection circuit	100 MΩ, 500 V DC

10. Technical inspections and maintenance.

Technical inspections and maintenance can be performed after disconnecting the power supply from the power network. The PSU does not require performing any specific maintenance measures, however, in the case of significant dust rate, its interior is recommended to be cleaned with compressed air. In the case of a fuse replacement, use a replacement of the same parameters.

Technical inspections should be carried out not less frequently than once per year. During the inspection, check batteries and run battery test.

4 weeks after installation, re-tighten all threaded connections Fig. 2 [2].

10.1 Battery replacement of LCD panel.

Estimated operating time of battery type CR2032 is about six years. After this period, battery will need to be replaced.

Battery replacement of the LCD panel should be done during mains operation or battery-assisted operation in order to avoid resetting the time settings.



CAUTION!

Removed batteries should be stored in a designated collection point. Do not reverse polarity of batteries. Improper use of battery may lead to explosion.



WEEE MARK

According to the EU WEE Directive – It is required not to dispose of electric or electronic waste as unsorted municipal waste and to collect such WEEE separately.



CAUTION! The power supply module unit is adapted for a sealed lead-acid battery (SLA). After the operation period it must not be disposed of but recycled according to the applicable law.

Pulsar sp. j.
Siedlec 150, 32-744 Łapczyca, Poland
Tel. (+48) 14-610-19-45
e-mail: sales@pulsar.pl
[http:// www.pulsar.pl](http://www.pulsar.pl)

