

DS-2CD1123G0E-I 2 MP IR Fixed Network Dome Camera



2.8 mm Fixed Lens



4 mm Fixed Lens



Key Features

- 1/2.8" progressive scan CMOS
- 1920 × 1080@30fps
- 2.8 mm/4 mm fixed lens
- 3D DNR
- Up to 30 m IR range
- IP67, IK10



Specification

Camera	
Image Sensor	1/2.8" progressive scan CMOS
Min. Illumination	Color: 0.01 Lux @(F1.2, AGC ON), 0.028Lux @ (F2.0, AGC ON)
Shutter Speed	1/3 s to 1/100, 000 s
Slow Shutter	Yes
Auto-Iris	No
Day & Night	IR cut filter
Digital Noise Reduction	3D DNR
WDR	DWDR
Angle Adjustment	Pan: 0° to 355°, tilt: 0° to 70°, rotate: 0° to 355°
Lens	
Focal length	2.8 mm, 4 mm
Aperture	F2.0
Focus	Fixed
FOV	2.8 mm, horizontal FOV 114.8°, vertical FOV 62°, diagonal FOV 135.5° 4 mm, horizontal FOV 86°, vertical FOV 46.5°, diagonal FOV 102.5°
Lens Mount	M12
IR	
IR Range	Up to 30 m
Wavelength	850 nm
Compression Standard	
Video Compression	Main stream: H.265/H.264 Sub stream: H.265/H.264/MJPEG
H.264 Type	Main Profile/High Profile/Baseline Profile
H.265 Type	Main Profile
Video Bit Rate	32 Kbps to 8 Mbps
Smart Feature-set	
Region of Interest	1 fixed region for main stream
Image	
Max. Resolution	1920 × 1080
Main Stream Max. Frame Rate	50Hz: 25fps (1920 × 1080, 1280 × 960, 1280 × 720) 60Hz: 30fps (1920 × 1080, 1280 × 960, 1280 × 720)
Sub-stream Max. Frame Rate	50Hz: 25fps (640 × 480, 640 × 360, 320 × 240) 60Hz: 30fps (640 × 480, 640 × 360, 320 × 240)
Image Enhancement	BLC, 3D DNR
Image Setting	Saturation, brightness, contrast, sharpness, AGC, white balance adjustable by client software or web browser
Day/Night Switch	Auto, scheduled, day, night
Network	
Alarm Trigger	Motion detection, video tampering alarm, illegal login
Protocols	TCP/IP, ICMP, HTTP, HTTPS, DHCP, DNS, RTP, RTSP, RTCP, NTP, IGMP, QoS, UDP
General Function	Anti-flicker, heartbeat, mirror, password protection, privacy mask, watermark
Firmware Version	V5.5.70
API	ONVIF (PROFILE S), ISAPI
Simultaneous Live View	Up to 6 channels
User/Host	Up to 32 users 3 levels: Administrator, Operator, and User

Client	iVMS-4200, Hik-Connect, iVMS-5200, iVMS-4500
Web Browser	IE8+, Chrome 31.0-44, Firefox 30.0-51, Safari 8.0+
Interface	
Communication Interface	1 RJ45 10M/100M self-adaptive Ethernet port
General	
Operating Conditions	-30 °C to 60 °C (-22 °F to 140 °F), humidity: 95% or less (non-condensing)
Power Supply	12 VDC ± 25%, 5.5 mm coaxial power plug PoE (802.3af, class 3)
Power Consumption and Current	12 VDC, 0.4 A, Max: 5 W PoE: (802.3af, 36 V to 57 V), 0.2 A to 0.1 A, Max: 6.5 W
Ingress Protection	IP67, IK10
Material	Front cover: plastic, back cover & bracket: metal
Dimensions	Camera: Ø 111 mm × 82.4 mm (4.4" × 3.2") With package: 134 mm × 134 mm × 108 mm (5.3" × 5.3" × 4.3")
Weight	Camera: Approx. 400 g (0.9 lb.) With package: Approx. 600 g (1.3 lb.)

Available Model

DS-2CD1123G0E-I (2.8/4 mm)

Dimension

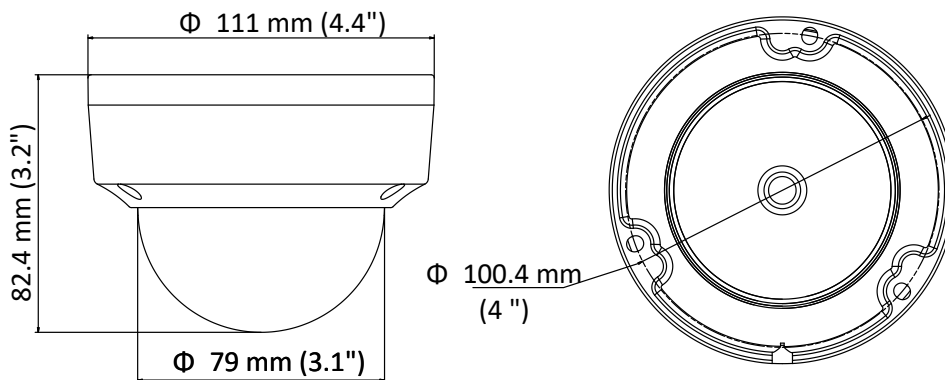

Accessories



DS-1259ZJ
Inclined Ceiling
Mount



DS-1271ZJ-110
Pendant Mount



DS-1272ZJ-110
Wall Mount



DS-1272ZJ-110B
Wall Mount



DS-1258ZJ
Wall Mount



DS-1276ZJ-SUS
Corner Mount



DS-1280ZJ-DM18
Junction Box



DS-1250ZJ
Rain Shade

Distributed by



DS-1253ZJ-M
Rain Shade

HIKVISION

Headquarters

No.555 Qianmo Road, Binjiang District,
Hangzhou 310051, China
T +86-571-8807-5998
overseasbusiness@hikvision.com

Hikvision USA
T +1-909-895-0400
sales.usa@hikvision.com

Hikvision Europe
T +31-23-55-42-770
info.eu@hikvision.com

Hikvision Middle East
T +971-4-8816086
salesme@hikvision.com

Hikvision Russia
T +7-495-669-67-99
saleru@hikvision.com

Hikvision India
T +91-22-28469900
sales@pramahikvision.com

Hikvision Italy
T +39-0438-6902
info.it@hikvision.com

Hikvision France
T +33(0)1-85-330-450
info.fr@hikvision.com

Hikvision Spain
T +34-91-737-16-55
info.es@hikvision.com

Hikvision Poland
T +48-22-460-01-50
poland@hikvision.com

Hikvision UK
T +01628-902140
support.uk@hikvision.com

Hikvision Singapore
T +65-6684-4718
sg@hikvision.com

Hikvision Oceania
T +61-2-8599-4233
salesau@hikvision.com

Hikvision Canada
T +1-909-895-0400
sales.usa@hikvision.com

Hikvision Korea
T +82-31-731-8841
sales.korea@hikvision.com

Hikvision Brazil
T +55 11 3318-0050
Latam.support@hikvision.com

Hikvision Africa
T +27 (10) 0351172
sale.africa@hikvision.com

Hikvision Hong Kong
T +852-2151-1761