

DS-2CE5AH8T-(A)VPIT3Z 5 MP Dome Camera



Key Features

- 5 MP high performance CMOS
- Auto focus
- 2560 × 1944 resolution
- 2.7 mm to 13.5 mm motorized vari-focal lens
- EXIR 2.0, smart IR, up to 60 m IR distance
- OSD menu, 3D DNR, 130 dB true WDR
- IP67, IK10
- Up the coax (HIKVISION-C)



Specification

Camera	
Image Sensor	5 megapixel progressive scan CMOS
Signal System	PAL/NTSC
Resolution	2560 (H) × 1944 (V)
Min. Illumination	Color: 0.003 Lux @ (F1.2, AGC ON), 0 Lux with IR
Frame Rate	TVI: 2 MP@25fps, 2 MP@30fps, 4 MP@25fps, 4 MP@30fps, 5 MP@20fps
Shutter Time	PAL: 1/25 s to 1/50, 000 s NTSC: 1/30 s to 1/50, 000 s
Lens	2.7 mm to 13.5 mm motorized vari-focal lens
Horizontal Field of View	92.3° to 29.3°
Lens Mount	Φ 14
Day & Night	IR cut filter
Angle Adjustment	Pan: 0° to 355°; Tilt: 0° to 75°; Rotate: 0° to 355°
Synchronization	Internal synchronization
WDR (Wide Dynamic Range)	≥ 130 dB
Menu	
AGC	Yes
D/N Mode	Auto/Color/BW (Black and White)
White Balance	Auto/Manual
BLC (Backlight Compensation)	Yes
WDR	Yes
3D DNR	Level 1 to 9
Privacy Mask	4 programmable privacy masks
Motion Detection	4 programmable areas
Language	English
Functions	Brightness, Sharpness, 3D DNR, Mirror, Smart IR
Interface	
Video Output	1 HD analog output
Video Output - Technology	TVI
General	
Operating Conditions	-40 °C to 60 °C (-40 °F to 140 °F), humidity: 90% or less (non-condensation)
Power Supply	-A: 9.6 VDC to 14.4 VDC; 19.2 VAC to 28.8 VAC.
Power Consumption	-A: Max. 8 W
Protection Level	IP67, IK10
Material	Metal
IR Range	Up to 60 m
Communication	Up the coax, Protocol: HIKVISION-C (TVI output)
Dimensions	Ø 145 mm × 111.3 mm (Ø 5.70" × 4.37")
Weight	Approx. 830 g (1.83 lb.)

Order Model

DS-2CE5AH8T-AVPIT3ZF

Dimension

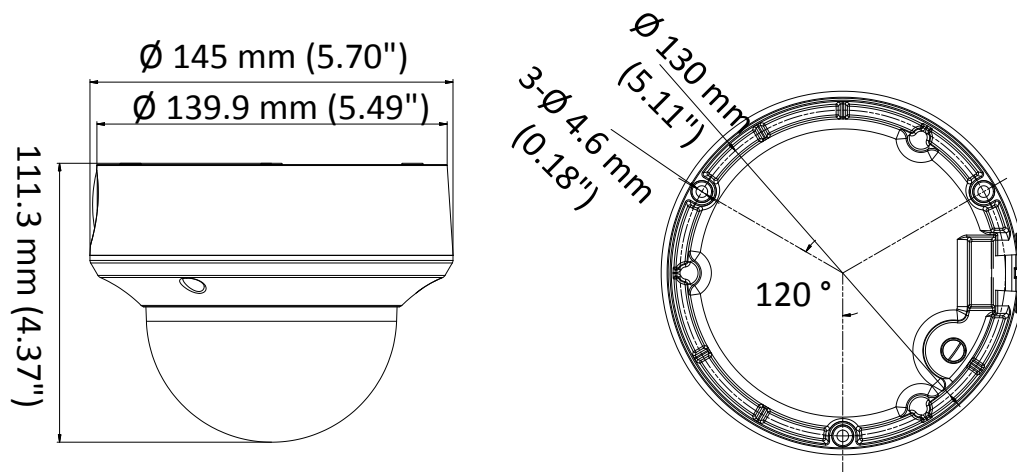

Accessory

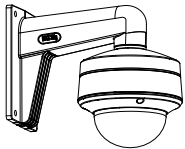

DS-1273ZJ-140-DM45
Wall Mount

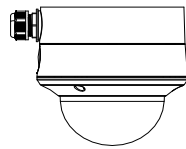
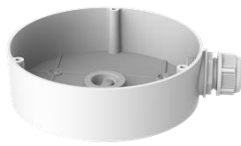

DS-1280ZJ-DM45
Junction Box

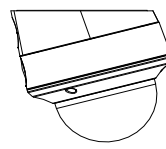
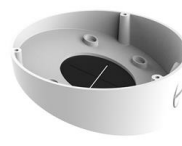

DS-1281ZJ-DM45
Inclined Ceiling Mount

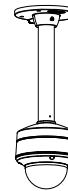

DS-1271ZJ-140-DM45
Pendant Mount

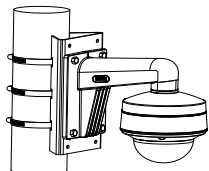

DS-1275ZJ-SUS
Vertical Pole Mount

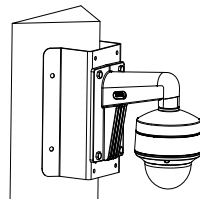

DS-1276ZJ-SUS
Corner Mount

Distributed by



HIKVISION

Headquarters

No.555 Qianmo Road, Binjiang District,
Hangzhou 310051, China
T +86-571-8807-5998
overseasbusiness@hikvision.com

Hikvision USA
T +1-909-895-0400
sales.usa@hikvision.com

Hikvision Italy
T +39-0438-6902
info.it@hikvision.com

Hikvision Singapore
T +65-6684-4718
sg@hikvision.com

Hikvision Africa
T +27 (10) 0351172
sale.africa@hikvision.com

Hikvision Europe
T +31-23-55-42-770
info.eu@hikvision.com

Hikvision France
T +33(0)1-85-330-450
info.fr@hikvision.com

Hikvision Oceania
T +61-2-8599-4233
salesau@hikvision.com

Hikvision Hong Kong
T +852-2151-1761

Hikvision Middle East
T +971-4-8816086
salesme@hikvision.com

Hikvision Spain
T +34-91-737-16-55
info.es@hikvision.com

Hikvision Canada
T +1-909-895-0400
sales.usa@hikvision.com

Hikvision Russia
T +7-495-669-67-99
saleru@hikvision.com

Hikvision Poland
T +48-22-460-01-50
poland@hikvision.com

Hikvision Korea
T +82-31-731-8841
sales.korea@hikvision.com

Hikvision India
T +91-22-28469900
sales@pramahikvision.com

Hikvision UK
T +01628-902140
support.uk@hikvision.com

Hikvision Brazil
T +55 11 3318-0050
Latam.support@hikvision.com