



LINEA 6 AC CAMERA HOUSING

Ceiling Mount Camera Housing,

Weatherproof IP66

Heater with thermostat, Blower kit,

Ceiling bracket BWRH6



USER FRIENDLY

All opening and closing operations can be done with just one tool.

FULL OPTIONAL

Power supply, heater and blower kit can be factory installed.

CEILING MOUNT

Ceiling bracket BWRH6 included.

SUITABLE FOR OUTDOOR AND INDOOR

Weatherproof rated, the integrated sunshield and the large window guarantee clear images and no vignetting









www.teknosystem.eu



LINEA 6 AC CAMERA HOUSING

ACCESSORIES

HT6	Heater with thermostat	
V6	Blower kit with thermostat	
VA6	Vandal proof glass (IK08)	
SS6	Sunshield	
AL6	Power supply unit 12VDC or 24VAC	
ALWR	Wide Range Power Supply Unit	
EL	Heater with thermostat	

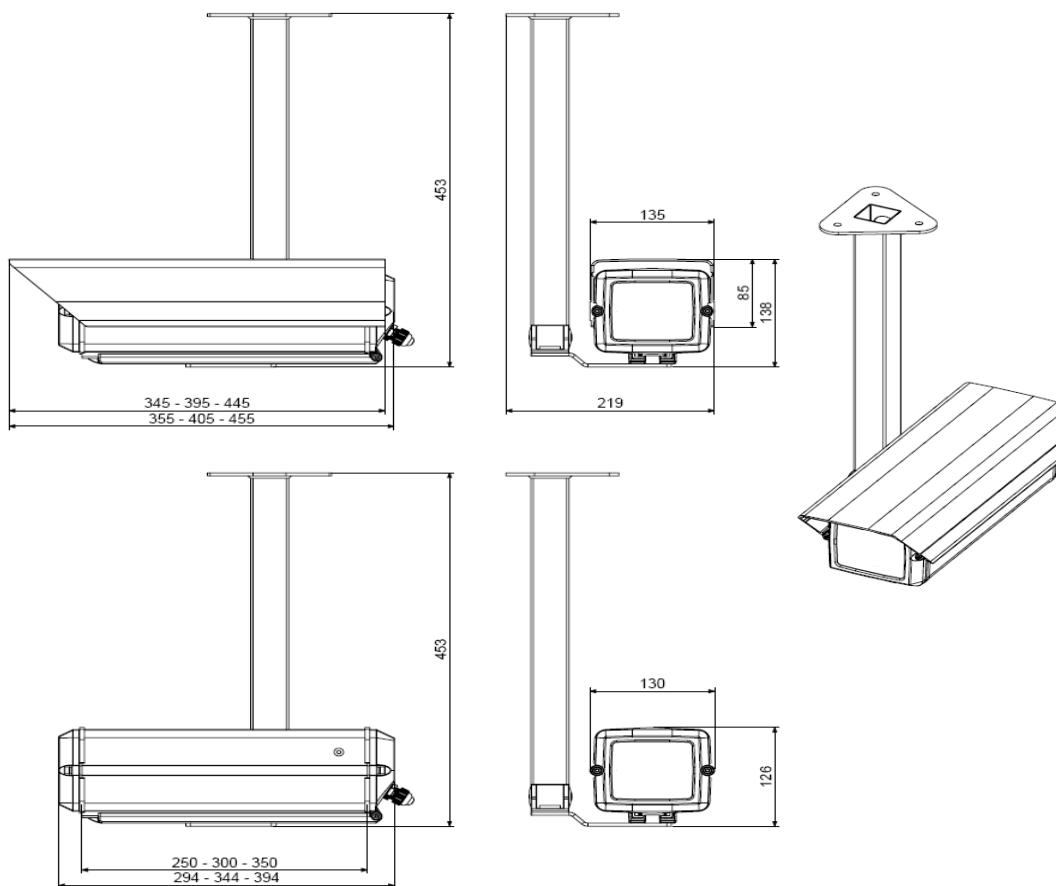



LINEA 6 AC CAMERA HOUSING

MODELS AND ACCESSORIES

	Bracket	Sunshield	Heater kit	Blower kit	Power supply	Vandal proof glass
KIT 6	A (Wall)				+ AL6 (12VDC or 24VAC)	
	P (Cable management)	+ SS6	+ HT6	+ V6 (IP 54)		+ VA6 (IK08)
	AC (Ceiling)				+ ALWR (wide range)	

SPECIFICATIONS

General

- Extruded aluminium body and sunshield
- Die cast Aluminium parts
- RAL9002 Polyester powder coating
- Supplied with: instruction manual, silicagel bag, ¼" camera fixing screw, BWRH6 wall bracket and swivel head.

Mechanical

- Internal usable area: 105 x 86mm
- Internal usable length: 250-300-350mm
- Usable Glass Windows 82x 72mm
- Zinc coated screws

Electrical

- Heater Thermostat T_{on} 15°C (59°F) \pm 5°C T_{off} 22°C (71.6°F) \pm 4°C
- Heater PTC 100-240V~ 40W
- Heater PTC 12-24V~ 20W
- Blower Thermostat T_{on} 37°C (98.6°F) \pm 4°C T_{off} 27°C(80.6°F) \pm 3°C
- Blower with double air filter, consumption 1W
- Camera power supply unit:
ALWR: Vin 88-264V~ 47/63Hz Vout 12VDC 2, 1A;
AL12 Vin 230V~ 50Hz Vout 12VDC 400mA;
AL24 Vin 230V~ 50Hz Vout 24V~ 50Hz 400mA;

Environment

- Indoor / Outdoor applications
- Temperature range with heater: -20°C (-4°F) up to +50°C (+122°F)
- IP66 weatherproof rating (according to EN60529)
- CE according to EN61000-6-3, EN60950, EN50130-4
- RoHS compliant

Tekno System S.p.A.

Via Rostoncello, 1 - 36010 Carrè – Italy

Phone: +39 0445 314324

Fax: +39 0445 314319

Email: info@teknoystem.eu



www.teknoystem.eu